









Cisco Unified IP Phone 6921, 6941, and 6961 User Guide for Cisco Unified Communications Manager 7.1 (SCCP)

Americas Headquarters

Cisco Systems, Inc.
170 West Tasman Drive
San Jose, CA 95134-1706
USA
<http://www.cisco.com>
Tel: 408 526-4000
800 553-NETS (6387)
Fax: 408 527-0883

Common Phone Tasks

Place a call	Go off-hook before or after dialing a number.
Redial a number	Press Redial .
Switch to handset during a call	Pick up the handset.
Switch to speaker or headset during a call	Press  or  , then hang up the handset.
Mute and un-mute a call	Press  .
View call history	Press  > Call History .
Hold and resume a call	Press  , to hold. Press Resume to resume the held call.
Transfer a call to new number	Press  , enter the number, then press it again.
Place an intercom call	Press the Intercom button, then enter a number if necessary. Speak after you hear the tone.
Start a standard conference call	Press  , dial the participant, then press it again.
Silence the ring for an incoming call	Press the Volume button down once.



Cisco, Cisco Systems, the Cisco logo, and the Cisco Systems logo are registered trademarks or trademarks of Cisco Systems, Inc. and/or its affiliates in the United States and certain other countries. All other trademarks mentioned in this document or Website are the property of their respective owners. The use of the word partner does not imply a partnership relationship between Cisco and any other company. (0705R)

© 2009 Cisco Systems, Inc. All rights reserved.

OL-20187-01



QUICK REFERENCE





Cisco Unified IP Phone 6921, 6941, and 6961 for Cisco Unified Communications Manager 7.1 (SCCP)









Softkeys
Phone Screen Icons
Buttons
Common Phone Tasks

Softkeys

All Calls	Lists all missed, placed, and received calls.
Answer	Answer a call.
Apply	Confirm a ringtone selection.
Call	Initiate a call.
Callback	Receive notification when a busy extension becomes available.
Cancel	Cancel an action or exit a screen without applying changes.
Clear	Clear all values.
Delete	Delete an entry from Call History.
Del Call	Delete a call from Call History.
Details	Opens the Details for a multiparty call in the Missed, Placed, and Received Call records.
Dial	Dial a selected number.
Divert	Send or redirect a call to voicemail or to a predetermined phone number.
Edit	Modify a name or email address.
EditDial	Modify a number.
Exit	Return to the previous screen.
Fwd All/Fwd OFF	Setup/cancel call forwarding.
GPickup	Answer a call that is ringing in another group or on another line.
Log Out	Sign out of Personal Directory.
Meet Me	Host a Meet Me conference call.
Missed	Open the record of missed calls.
more	Display additional softkeys.











New Call	Make a new call.
OK	Confirm a selection.
OPickup	Answer a call that is ringing in an associated group.
Park	Store a call.
Play	Play ringtone.
PickUp	Answer a call that is ringing on another phone in your group.
Redial	Redial the most recently dialed number.
Remove	Remove a conference participant or an entry.
Resume	Resume a call on hold.
Save	Save the chosen settings.
Search	Search for a directory listing.
Select	Select the highlighted option.
Set	Set a ringtone.
Submit	Enter user information.
Swap	Toggle between two existing calls.
Update	Update an entry in Personal Directory.
>>	Move through entered characters.
	Backspace to delete characters.
	Back.

Phone Screen Icons











	Off-hook
	On-hook
	Connected call
	Incoming call
	Missed call
	Received call
	Placed call
	Call on hold

Feature Icons

(If available on your phone)

	Message waiting
	Shared line in use
	Speed dial line
	Line Status indicator—monitored line is in-use
	Line Status indicator—monitored line is idle
	Line Status indicator—monitored line is ringing (Call Pickup only)
	Line Status indicator—monitored line is in do not disturb (DND)
	Idle intercom line
	One-way intercom call (whisper)
	Two-way intercom call (connected)

Buttons

	Applications
	Contacts
	Messages
	Transfer
	Hold
	Conference
	Volume
	Speakerphone
	Mute
	Headset
	Navigation bar and Select button

For the *Cisco Unified IP Phone Quick Start Guides*, go to this URL:

http://www.cisco.com/en/US/products/ps10326/products_user_guide_list.html

Contents

Your Phone	1
Cisco Unified IP Phone 6921	1
Phone Connections	1
Buttons and Hardware	3
Phone Screen	5
Footstand	5
Higher Viewing Angle	7
Lower Viewing Angle	8
Handset Rest	9
Cisco Unified IP Phone 6941	10
Phone Connections	10
Buttons and Hardware	12
Phone Screen	15
Footstand	15
Higher Viewing Angle	17
Lower Viewing Angle	18
Handset Rest	19
Cisco Unified IP Phone 6961	20
Phone Connections	20
Buttons and Hardware	22
Phone Screen	24
Footstand	24
Higher Viewing Angle	26
Lower Viewing Angle	27
Handset Rest	28
Applications	29
Phone Applications	29
Call History	29

- View Call History 30
- View Call Record Details 30
- Filter Call History 30
- Dial From Call History 30
- Clear Call History 31
- Delete Call Record From Call History 31
- Preferences 32
 - Ring Tones 32
 - Contrast 32
- Services 33
 - Access Services 33
- Phone Information 33
 - View Phone Information 33
- Administrator Settings 34

Contacts 35

- Phone Contacts 35
 - Corporate Directory 35
 - Search for and Dial a Contact 35
 - Search for and Dial a Contact While on a Call 36
 - Personal Directory 36
 - Personal Directory Options 37
 - Fast-Dial Codes with Personal Directory 39

Messages 40

- Voice Messages 40
 - Personalize Your Voicemail 40
 - Check for Voice Messages 40
 - Listen to Voice Messages 41

Calling Features 42

- Feature Buttons and Softkeys 42
- Auto Answer 43
 - Auto Answer with Your Headset 43
 - Auto Answer with Your Speakerphone 43
- Call Back 43

Set up a Call Back Notification	44
Call Forward All	44
Forward Calls on a Primary Line	45
Call Park	45
Park and Retrieve a Call Using Park	46
Park and Retrieve a Call Using Assisted Directed Call Park	46
Park and Retrieve a Call Using Manual Directed Call Park	46
Call Pickup	47
Answer a Call Using Pickup	47
Answer a Call Using Group Pickup and a Group Pickup Number	47
Answer a Call Using Group Pickup and a Phone Number	48
Answer a Call Using Other Pickup	48
Call Waiting	48
Respond to a Call Waiting Notification	48
Codes	49
Place a Call Using a Client Matter Code	49
Place a Call Using a Forced Authorization Code	49
Conference	49
Add Another Party to Your Call to Create a Conference	50
Combine Calls Across Lines to Create a Conference	50
Swap Between Calls Before Completing a Conference	50
End a Conference	50
View Conference Participants	50
Remove Conference Participants	50
Divert	51
Divert a Call	51
Do Not Disturb	51
Turn DND On and Off	51
Extension Mobility	52
Enable Extension Mobility	52
Fast Dial	52
Place a Call with a Fast-Dial Button	52
Hold	53
Hold and Resume a Call	53

Swap Between Held and Active Calls on Multiple Lines	53
Put a Call on Hold by Answering a New Call on Another Line	53
Determine if a Shared Line is on Hold	53
Hold Reversion	53
Respond to a Hold Reversion Notification	54
Hunt Groups	54
Sign In and Out of a Hunt Group	54
Intercom	54
Place an Intercom Call	54
Receive an Intercom Call	55
Line Status	55
Line Status Indicators	55
Malicious Call Identification	56
Trace a Suspicious Call	56
Meet Me	56
Host a Meet-Me Conference	56
Join a Meet-Me Conference	56
Mobile Connect	57
Turn On or Off Mobile Connect to All Your Remote Destinations From Your Desk Phone	57
Switch an In-Progress Call on Your Desk Phone to a Mobile Phone	57
Switch an In-Progress Call From a Mobile Phone to Your Desk Phone	58
Mute	58
Mute Your Phone	58
On-hook Dialing	58
Dial a Number On-hook	58
Privacy	58
Enable Privacy on a Shared Line	59
Quality Reporting Tool	59
Report Problems on Your Phone	59
Redial	59
Redial a Number	59
Shared Lines	60
Speed Dial	60
Place a Call with a Speed-Dial Button	61

Place a Call with a Speed-Dial Code	61
Transfer	61
Transfer a Call to Another Number	61
Use Direct Transfer to Connect Calls Across Lines	62
Swap Between Calls Before Completing a Transfer	62
Web Dialer	62
Use Web Dialer with Cisco Directory	62
Use Web Dialer with Another Online Corporate Directory	62
Set Up, View, or Change Web Dialer Preferences	63
Sign Out of Web Dialer	63
User Options	64
User Options Web Pages	64
Sign In and Out of User Options Web Pages	64
Device	65
Select a Device From the User Options Web Pages	65
Customize Do Not Disturb Options	65
Line Settings	66
Set Up Call Forwarding Per Line	66
Change the Voice Message Indicator Setting Per Line	66
Change the Audible Voice Message Indicator Setting Per Line	67
Change the Ring Settings Per Line	67
Change or Create a Line Text Label for Your Phone Display	67
Speed Dial on the Web	68
Set Up Speed-Dial Buttons	68
Set Up Speed-Dial Codes	68
Phone Services	68
Subscribe to a Service	69
Search for Services	69
Change or End Services	69
Change a Service Name	70
Add a Service to an Available Programmable Feature Button	70
User Settings	70
Change Your Browser Password	70
Change Your PIN	71

Change the Language for Your User Options Web Pages	71
Change the Language for Your Phone Display	71
Directory	71
Personal Address Book	72
Add a New PAB Entry	72
Search for a PAB Entry	72
Edit a PAB Entry	72
Delete a PAB Entry	72
Assign a Feature Button for Personal Address Book	72
Fast Dials	73
Assign a Feature Button for Fast Dial	73
Assign a Fast Dial Code to a PAB Entry	73
Assign a Fast Dial Code to a Phone Number Without Using a PAB Entry	74
Search for a Fast Dial Entry	74
Edit a Fast Dial Phone Number	74
Delete a PAB Entry	74
Mobility Settings	75
Add a New Remote Destination	75
Create an Access List	76
Plugins	76
Access Plugins	76
FAQs and Troubleshooting	77
Frequently Asked Questions	77
Troubleshooting Tips	77
Conference	77
Personal Directory	78
Shared Lines	78
User Options	79
Product Safety, Security, Accessibility, and Related Information	80
Safety and Performance Information	80
Power Outage	80
External Devices	80
Cisco Product Security	81

Accessibility Features	81
Hearing Impaired Accessibility Features	81
Vision Impaired and Blind Accessibility Features	85
Mobility Impaired Accessibility Features	87
Additional Information	90
Warranty	91
Cisco One-Year Limited Hardware Warranty Terms	91

Your Phone

Cisco Unified IP Phone 6921

The Cisco Unified IP Phone 6921 provides these features:

- Phone connections
- Buttons and hardware
- Phone screen
- Footstand
- Handset rest

Phone Connections

For your phone to work, it must be connected to the corporate IP telephony network. Your system administrator can help you connect your phone.

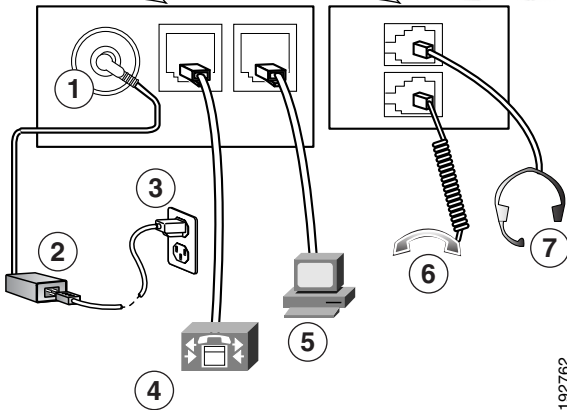







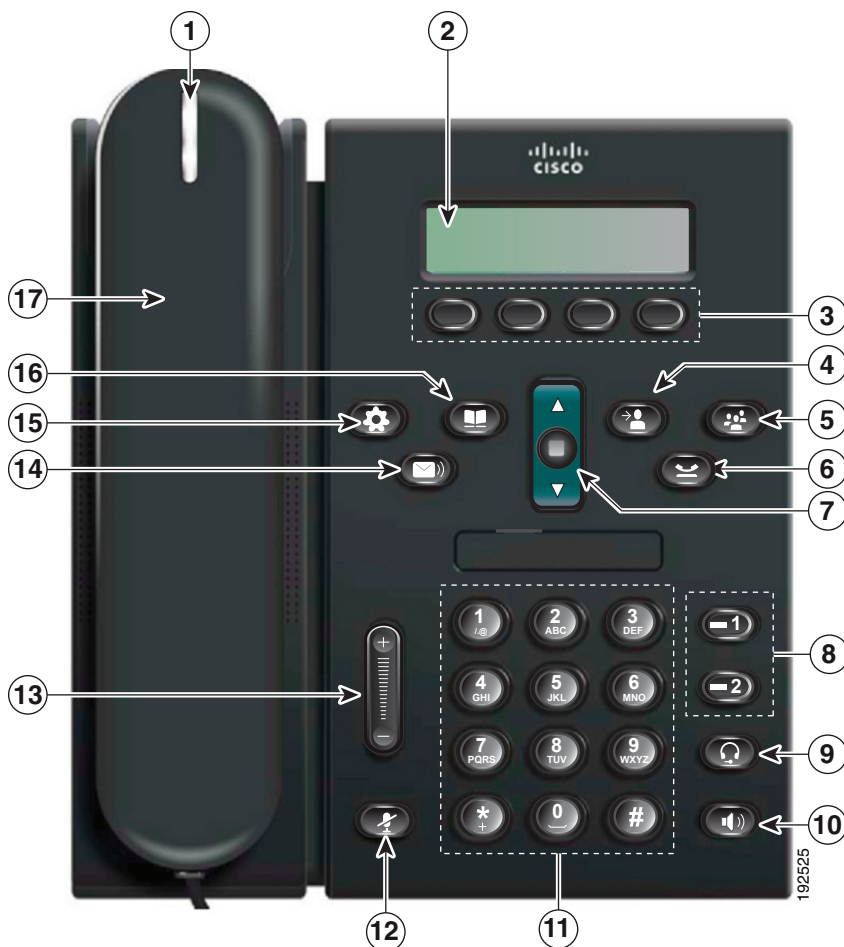

192762





1	DC adaptor port (DC48V).	5	Access port (10/100 PC) connection.
2	AC-to-DC power supply (optional).	6	Handset connection.
3	AC power wall plug (optional).	7	Analog headset connection (optional).
4	Network port (10/100 SW) connection. IEEE 802.3af power enabled.		

Buttons and Hardware



1	Handset light strip	Indicates an incoming call (flashing red) or new voice message (steady red).
2	Phone screen	Shows information about your phone such as directory number, active call and line status, softkey options, speed dials, placed calls, and phone menu listings.
3	Softkey buttons 	Depending on how your system administrator sets up the phone, enable softkey options displayed on your phone screen.

4	Transfer button 	Transfers a call.
5	Conference button 	Creates a conference call.
6	Hold button 	Places an active call on hold.
7	Navigation bar and Select button 	<p>The Navigation bar allows you to scroll through menus and highlight items. When phone is on-hook, displays phone numbers from your Placed Call listing (up arrow) or your speed dials (down arrow).</p> <p>The Select button (in the middle of the Navigation bar) allows you to select a highlighted item.</p>
8	Line 1 and Line 2 buttons 	<p>Line 1 selects the primary phone line.</p> <p>Depending on how your system administrator sets up the phone, Line 2 may provide access to:</p> <ul style="list-style-type: none"> • Secondary phone line • Speed-dial number (speed-dial button) • Web-based service (for example, a Personal Address Book button) <p>Buttons illuminate to indicate status:</p> <ul style="list-style-type: none"> • Green, steady—Active call • Green, flashing—Held call • Amber, flashing—Incoming call or reverting call • Red, steady—Remote line in use (shared line) • Red, flashing—Remote line on hold
9	Headset button 	Toggles the headset on or off. When the headset is on, the button is lit.
10	Speakerphone button 	Toggles the speakerphone on or off. When the speakerphone is on, the button is lit.
11	Keypad	Allows you to dial phone numbers, enter letters, and select menu items (by entering the item number).
12	Mute button 	Toggles the microphone on or off. When the microphone is muted, the button is lit.

13	Volume button 	Controls the handset, headset, and speakerphone volume (off-hook) and the ringer volume (on-hook).
14	Messages button 	Auto-dials your voicemail system (varies by system).
15	Applications button 	Opens/closes the Applications menu. Use it to access call history, user preferences, phone settings, and phone model information.
16	Contacts button 	Opens/closes the Directories menu. Use it to access personal and corporate directories.
17	Handset	Phone handset.

Phone Screen

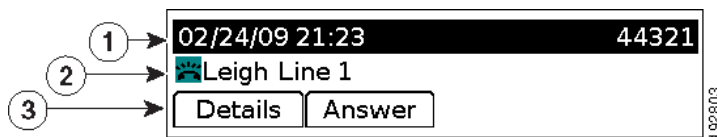

1	Header	Displays date, time, and directory number.
2	Line details and other phone information	During a call, displays details for the active line. If not on a call, displays line text label and other information such as placed calls, speed dials, and phone menu listings.
3	Softkey labels	Display softkeys for available features or actions.

Footstand

If your phone is placed on a table or desk, the footstand can be connected to the back of the phone for a higher or lower viewing angle, depending on your preference.



1 Footstand slots for a higher viewing angle	2 Footstand slots for a lower viewing angle
---	--

Higher Viewing Angle



Lower Viewing Angle



193865

Handset Rest

Your system administrator may have mounted your phone on a wall. With a wall-mounted phone, you might need to adjust the handset rest to ensure that the receiver will not slip out of the cradle.

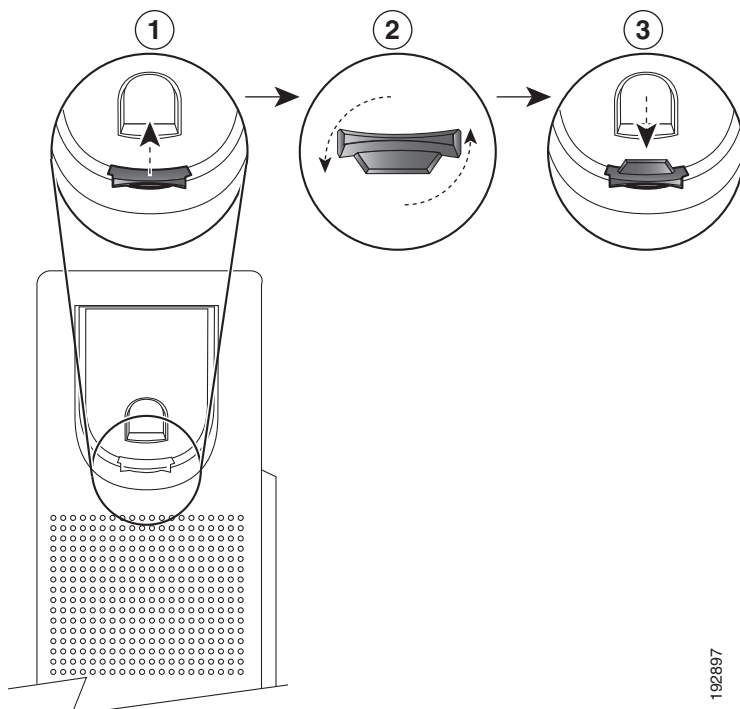

192897

1	Remove the handset from the cradle and pull the plastic tab from the handset rest.
2	Rotate the tab 180 degrees.
3	Hold the tab between two fingers, with the corner notches facing you. Make sure the tab lines up evenly with the slot in the handset cradle.
4	Press the tab evenly into the slot. An extension protrudes from the top of the rotated tab. Return the handset to the handset rest.

Cisco Unified IP Phone 6941

The Cisco Unified IP Phone 6941 provides these features:

- Phone connections
- Buttons and hardware
- Phone screen
- Footstand
- Handset rest

Phone Connections

For your phone to work, it must be connected to the corporate IP telephony network. Your system administrator can help you connect your phone.

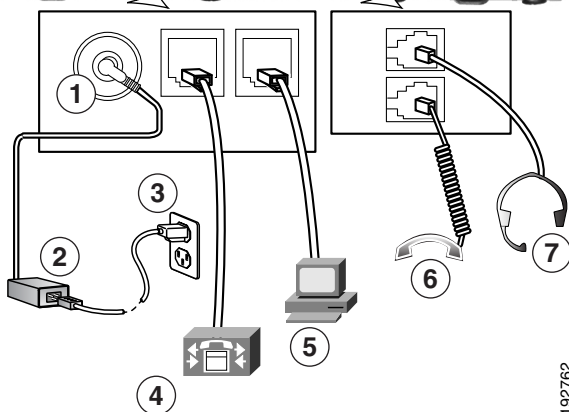







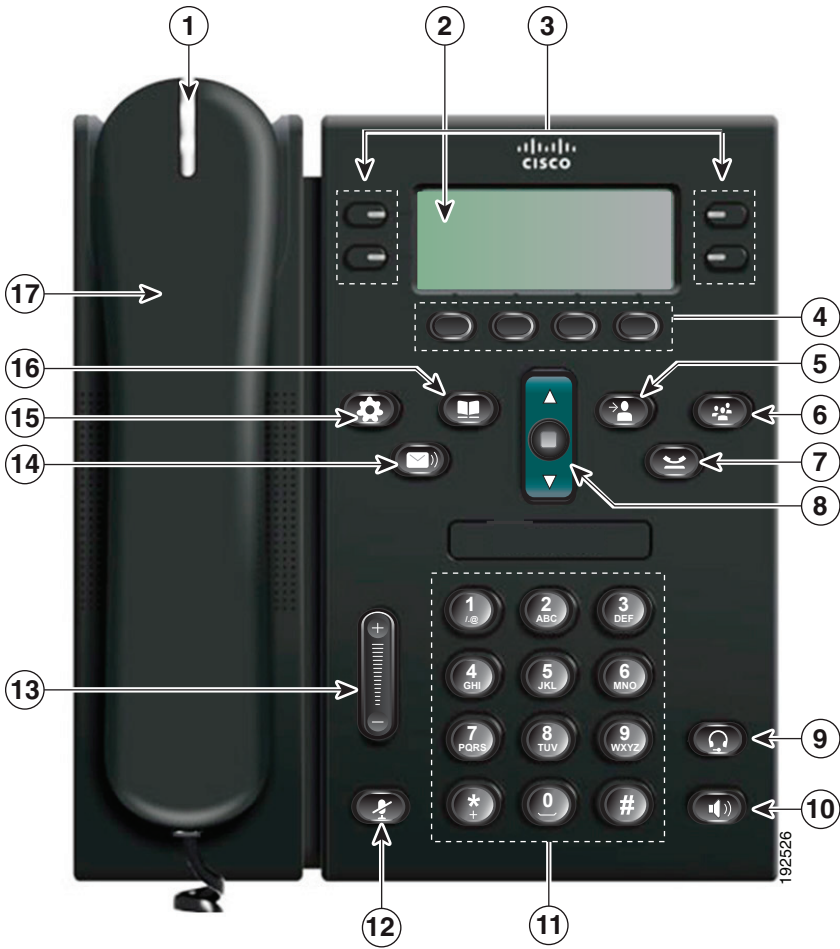





192762

1	DC adaptor port (DC48V).	5	Access port (10/100 PC) connection.
2	AC-to-DC power supply (optional).	6	Handset connection.
3	AC power wall plug (optional).	7	Analog headset connection (optional).
4	Network port (10/100 SW) connection. IEEE 802.3af power enabled.		

Buttons and Hardware



1	Handset light strip	Indicates an incoming call (flashing red) or new voice message (steady red).
2	Phone screen	Shows information about your phone such as directory number, active call and line status, softkey options, speed dials, placed calls, and phone menu listings.
3	Programmable feature buttons 	Depending on how your system administrator sets up the phone, programmable feature buttons (on each side of the phone screen) provide access to: <ul style="list-style-type: none"> • Phone lines and intercom lines • Speed-dial numbers (speed-dial buttons, including the Line Status speed-dial features) • Web-based services (for example, a Personal Address Book button) • Call features (for example, a Privacy button) Buttons illuminate to indicate status: <ul style="list-style-type: none"> • Green, steady—Active call or two-way intercom call • Green, flashing—Held call • Amber, steady—Privacy in use, one-way intercom call, DND active, or logged into Hunt Group • Amber, flashing—Incoming call or reverting call • Red, steady—Remote line in use (shared line or Line Status) • Red, flashing—Remote line on hold
4	Softkey buttons 	Depending on how your system administrator sets up the phone, enable softkey options displayed on your phone screen.
5	Transfer button 	Transfers a call.
6	Conference button 	Creates a conference call.
7	Hold button 	Places an active call on hold.

8	Navigation bar and Select button 	The Navigation bar allows you to scroll through menus and highlight items. When phone is on-hook, displays phone numbers from your Placed Call listing (up arrow) or your speed dials (down arrow). The Select button (in the middle of the Navigation bar) allows you to select a highlighted item.
9	Headset button 	Toggles the headset on or off. When the headset is on, the button is lit.
10	Speakerphone button 	Toggles the speakerphone on or off. When the speakerphone is on, the button is lit.
11	Keypad	Allows you to dial phone numbers, enter letters, and select menu items (by entering the item number).
12	Mute button 	Toggles the microphone on or off. When the microphone is muted, the button is lit.
13	Volume button 	Controls the handset, headset, and speakerphone volume (off-hook) and the ringer volume (on-hook).
14	Messages button 	Auto-dials your voice messaging system (varies by system).
15	Applications button 	Opens/closes the Applications menu. Use it to access call history, user preferences, phone settings, and phone model information.
16	Contacts button 	Opens/closes the Directories menu. Use it to access personal and corporate directories.
17	Handset	Phone handset.

Phone Screen

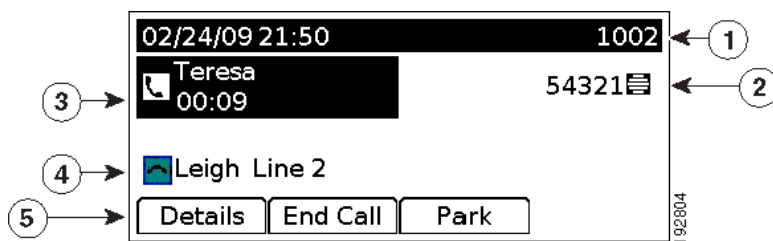

1	Header	Displays date, time, and directory number.
2	Line text label with icon	Displays text label and icon for phone or intercom line, speed-dial numbers, or services, depending on your configuration.
3	Primary line details and other phone information	Displays line label and call details for the primary line, and other phone information such as placed calls, speed dials, and phone menu listings.
4	Secondary line details and other phone information	Displays line label and call details for the secondary line, and other phone information such as placed calls, speed dials, and phone menu listings.
5	Softkey labels	Display softkeys for available features or actions.

Footstand

If the phone is placed on a table or desk, the footstand can be connected to the back of your phone for a higher or lower viewing angle, depending on your preference.

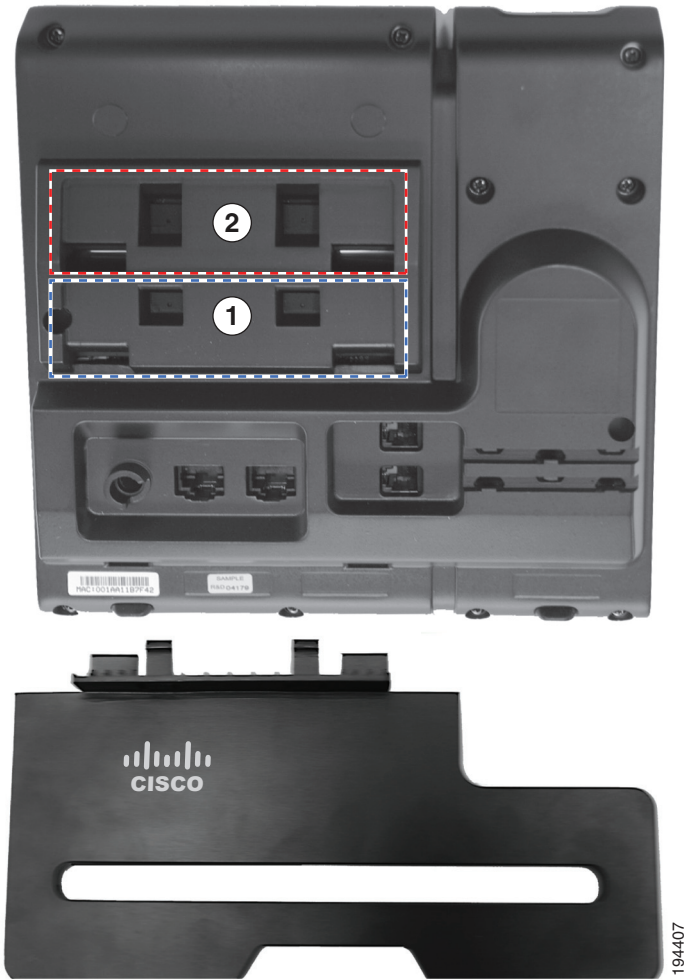

1 Footstand slots for a higher viewing angle	2 Footstand slots for a lower viewing angle
---	--

Higher Viewing Angle



Lower Viewing Angle



Handset Rest

Your system administrator may have mounted your phone on a wall. With a wall-mounted phone, you might need to adjust the handset rest to ensure that the receiver will not slip out of the cradle.

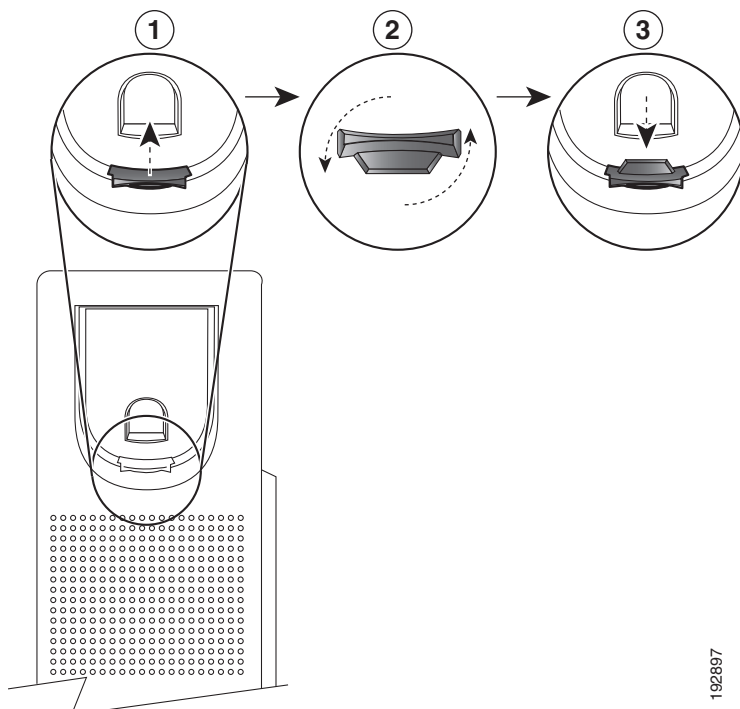

192897

1	Remove the handset from the cradle and pull the plastic tab from the handset rest.
2	Rotate the tab 180 degrees.
3	Hold the tab between two fingers, with the corner notches facing you. Make sure the tab lines up evenly with the slot in the handset cradle.
4	Press the tab evenly into the slot. An extension protrudes from the top of the rotated tab. Return the handset to the handset rest.

Cisco Unified IP Phone 6961

The Cisco Unified IP Phone 6961 provides these features:

- Phone connections
- Buttons and hardware
- Phone screen
- Footstand
- Handset rest

Phone Connections

For your phone to work, it must be connected to the corporate IP telephony network. Your system administrator can help you connect your phone.

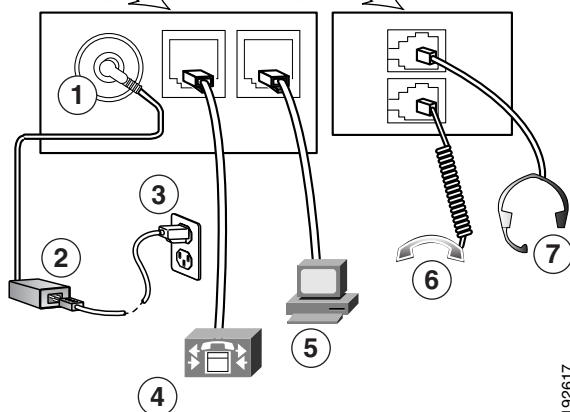







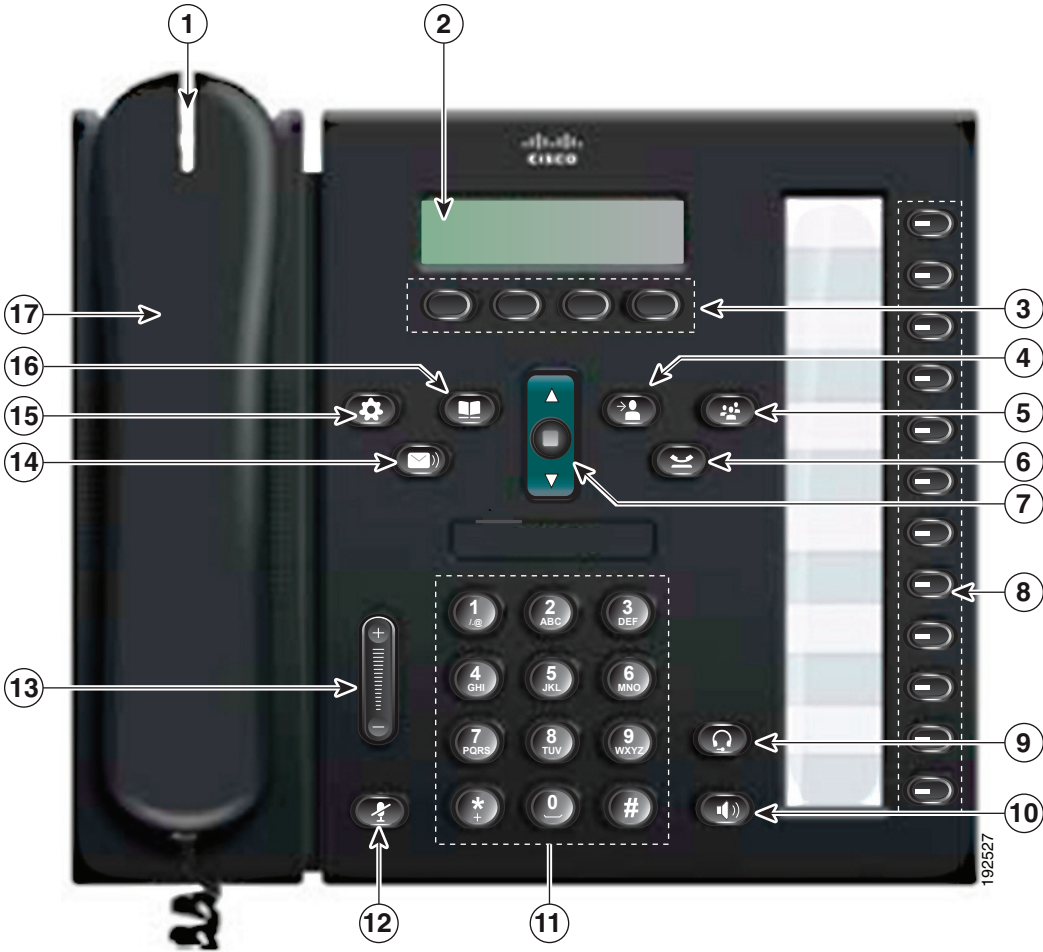

192617





1	DC adaptor port (DC48V).	5	Access port (10/100 PC) connection.
2	AC-to-DC power supply (optional).	6	Handset connection.
3	AC power wall plug (optional).	7	Headset connection (optional).
4	Network port (10/100 SW) connection. IEEE 802.3af power enabled.		

Buttons and Hardware



1	Handset light strip	Indicates an incoming call (flashing red) or new voice message (steady red).
2	Phone screen	Shows information about your phone such as directory number, active call and line status, softkey options, speed dials, placed calls, and phone menu listings.
3	Softkey buttons 	Depending on how your system administrator sets up the phone, enable softkey options displayed on your phone screen.

4	Transfer button 	Transfers a call.
5	Conference button 	Creates a conference call.
6	Hold button 	Places an active call on hold.
7	Navigation bar and Select button 	The Navigation bar allows you to scroll through menus and highlight items. When phone is on-hook, displays phone numbers from your Placed Call listing (up arrow) or your speed dials (down arrow). The Select button allows you to select a highlighted item.
8	Programmable feature buttons 	Depending on how your system administrator sets up the phone, programmable feature buttons provide access to: <ul style="list-style-type: none"> • Phone lines and intercom lines • Speed-dial numbers (speed-dial buttons, including the Line Status speed-dial features) • Web-based services (for example, a Personal Address Book button) • Call features (for example, a Privacy button) Buttons illuminate to indicate status: <ul style="list-style-type: none"> • Green, steady—Active call or two-way intercom call • Green, flashing—Held call • Amber, steady—Privacy in use, one-way intercom call, DND active, or logged into Hunt Group • Amber, flashing—Incoming call or reverting call • Red, steady—Remote line in use (shared line or Line Status) • Red, flashing—Remote line on hold
9	Headset button 	Toggles the headset on or off. When the headset is on, the button is lit.
10	Speakerphone button 	Toggles the speakerphone on or off. When the speakerphone is on, the button is lit.
11	Keypad	Allows you to dial phone numbers, enter letters, and select menu items (by entering the item number).

12	Mute button 	Toggles the microphone on or off. When the microphone is muted, the button is lit.
13	Volume button 	Controls the handset, headset, and speakerphone volume (off-hook) and the ringer volume (on-hook).
14	Messages button 	Auto-dials your voice messaging system (varies by system).
15	Applications button 	Opens/closes the Applications menu. Use it to access call history, user preferences, phone settings, and phone model information.
16	Contacts button 	Opens/closes the Directories menu. Use it to access personal and corporate directories.
17	Handset	Phone handset.

Phone Screen

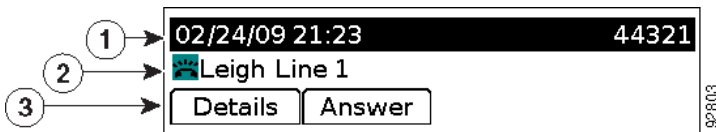

1	Header	Displays date, time, and directory number.
2	Line details and other phone information	During a call, displays details for the active line. If not on a call, displays line text label and other information such as placed calls, speed dials, and phone menu listings.
3	Softkey labels	Display softkeys for available features or actions.

Footstand

If the phone is placed on a table or desk, the footstand can be connected to the back of your phone for a higher or lower viewing angle, depending on your preference.



1	Footstand slots for a higher viewing angle	2	Footstand slots for a lower viewing angle
----------	--	----------	---

Higher Viewing Angle



193864

Lower Viewing Angle



Handset Rest

Your system administrator may have mounted your phone on a wall. With a wall-mounted phone, you might need to adjust the handset rest to ensure that the receiver will not slip out of the cradle.

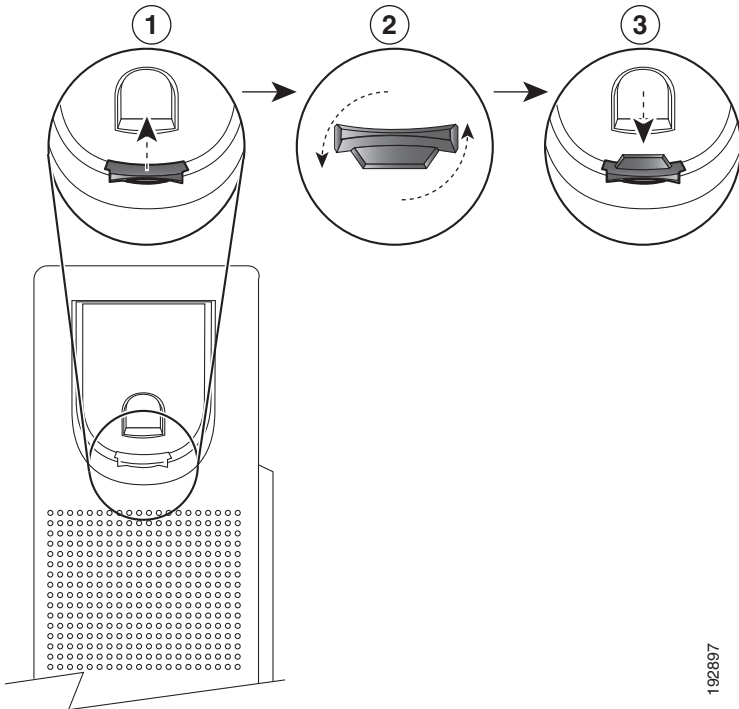

1	Remove the handset from the cradle and pull the plastic tab from the handset rest.
2	Rotate the tab 180 degrees.
3	Hold the tab between two fingers, with the corner notches facing you. Make sure the tab lines up evenly with the slot in the handset cradle.
4	Press the tab evenly into the slot. An extension protrudes from the top of the rotated tab. Return the handset to the handset rest.

Applications

Phone Applications

Phone applications allow you to access the following:

- Call History
- Preferences
- Services
- Phone Information
- Administrator Settings (For system administrators only.)

Call History



Call History allows you to view information about the last 150 calls on your phone. A call icon is displayed to indicate the type of call:

- Received
- Placed
- Missed



The caller ID is displayed with the call icon. If the caller ID is unavailable, then the phone number is displayed. If the phone number is unavailable, then “Unknown” is displayed. All Call History items are integrated into one list and are ordered by time (latest to oldest). There is 150 call limit per phone and not per line. For example, if a phone has multiple lines, the 150 call limit is for all lines combined.

You can sort the Call History list by all lines, each line, or by missed calls. You can also dial a number directly from the Call History list.



View Call History

1. Press the **Applications** button  .
2. Select **Call History**. (Use the Navigation bar and button to scroll and select.)
3. Select **All Lines** or the line that you want to view.
4. Press the  softkey to return to the Call History screen.

View Call Record Details

1. Press the **Applications** button  .
2. Select **Call History**. (Use the Navigation bar and button to scroll and select.)
3. Select **All Lines** or the line that you want to view.
4. Select a call record and press the **Details** softkey (you may need to press the **more** softkey first).
5. Press the  softkey to return to the Call History list.



Filter Call History

1. Press the **Applications** button  .
2. Select **Call History**. (Use the Navigation bar and button to scroll and select.)
3. Select **All Lines** or the line that you want to view.
4. The Call History list displays only the missed calls on the selected line.
5. To view all calls in the Call History list, press the **All Calls** softkey.
6. Press the  softkey to return to the Call History screen.

Dial From Call History

1. Press the **Applications** button  .
2. Select **Call History**. (Use the Navigation bar and button to scroll and select.)
3. Select **All Lines** or the line that you want to view.
4. From the Call History list, select the call you want to dial and do one of the following:
 - Press the **Call** softkey.
 - Press the line key.
 - Pick up the handset.
 - Press the speakerphone or headset button.

Edit Number From Call History

1. Press the **Applications** button  .
2. Select **Call History**. (Use the Navigation bar and button to scroll and select.)
3. Select **All Lines** or the line that you want to view.
4. Select the call you want to edit.
5. Press the **EditDial** softkey (you may need to press the **more** softkey first).
6. Press the **>>** softkey to move the cursor to the right and press the **<<** softkey to move the cursor to the left.
7. Press the  softkey to delete numbers.
8. Press the **Dial** softkey to dial the edited number (you may need to press the **more** softkey first).
9. Press the  softkey to return to the Call History list.

Clear Call History

1. Press the **Applications** button  .
2. Select **Call History**. (Use the Navigation bar and button to scroll and select.)
3. Select **All Lines** or the line that you want to view.
4. Press the **Clear** softkey (you may need to press the **more** softkey first).
5. Press the **Delete** softkey to delete the Call History list, or press the **Cancel** softkey to go back to the Call History screen.

Delete Call Record From Call History

1. Press the **Applications** button  .
2. Select **Call History**. (Use the Navigation bar and button to scroll and select.)
3. Select **All Lines** or the line that you want to view.
4. Select the call you want to delete.
5. Press the **Del Call** softkey (you may need to press the **more** softkey first).
6. Press the **Delete** softkey to delete the call, or press the **Cancel** softkey to go back to the Call History screen.

Preferences



Preferences allows you to set these user preferences:

- Ring Tone
- Contrast

Ring Tones

You can customize how your phone indicates an incoming call and a new voice mail message. You can also adjust the ringer volume for your phone.

Change Ringtone for a Line

1. Press the **Applications** button  .
2. Select **Preferences**. (Use the Navigation bar and button to scroll and select.)
3. Select **Ringtone**.
4. Select a ringtone.
5. Press the **Play** softkey to play a sample.
6. Press the **Set** softkey to select the ringtone.
7. Press the **Apply** softkey to confirm your selection, or press the **Cancel** softkey to go back to the Ringtone screen.
8. Press the  softkey to return to the Preferences screen.

Contrast

You can adjust your phone screen contrast level. The default contrast level setting is 50%.

Adjust the Contrast

1. Press the **Applications** button  .
2. Select **Preferences**. (Use the Navigation bar and button to scroll and select.)
3. Select **Contrast**.
4. To increase contrast, press the up arrow on the Navigation bar. To decrease contrast, press the down arrow.
5. Press the **Save** softkey to set the contrast level, or press the **Cancel** softkey to exit.

Services

Phone services can include special phone features, network data, and web-based information (such as stock quotes and movie listings). The services available for your phone depend on the phone system configuration and the services you are subscribed to. For more information, see your system administrator.

Access Services

1. Press the **Applications** button  .
2. Select **Services**. (Use the Navigation bar and button to scroll and select.)
3. Select the service you want to access.
4. Press the **Select** softkey, or press the **Exit** softkey to return to the Applications screen.

Phone Information

Phone Information allows you to view the following model information for your phone:

- Model Number
- IP Address
- MAC Address
- Active Load
- Inactive Load
- Last Upgrade
- Active Server
- Stand-by-Server
- Backlight On Time
- Backlight On Duration
- Backlight Idle Timeout

View Phone Information

1. Press the **Applications** button  .
2. Select **Phone Information**. (Use the Navigation bar and button to scroll and select.)
3. Press the **Exit** softkey to return to the Applications screen.

Administrator Settings

For information on accessing and changing the Administrator Settings, see your system administrator.

Contacts

Phone Contacts

The Cisco Unified IP Phones 6921, 6941, and 6961 provide you with access to corporate and personal contacts using these directories:

- Corporate Directory
- Personal Directory

Corporate Directory



The corporate directory contains corporate contacts that you can access on your phone. Your system administrator sets up and maintains the directory.

You can dial calls from your corporate directory in two ways:





- When you are not on another call.
- When you are on another call.

Search for and Dial a Contact

1. Press the **Contacts** button .
2. Select **Corporate Directory**. (Use the Navigation bar and button to scroll and select.)
3. Select any of these criteria to search for a co-worker:
 - First name
 - Last name
 - Number
4. Enter the search criteria information, press the **Submit** softkey, and select a contact.
5. To dial a contact, use one of these options:
 - Press the **Dial** softkey.
 - Press the **Select** button.
 - Press the contact label number.
 - Press a line button.

- Press the **Speakerphone** button .
- Press the **Headset** button .
- Pick up the handset.

Search for and Dial a Contact While on a Call

1. Press the **Contacts** button .
2. Select **Corporate Directory**. (Use the Navigation bar and button to scroll and select.)
3. Select any of these criteria to search for a co-worker:
 - First name
 - Last name
 - Number
4. Enter the information, then select **Search > Dial**.
5. Select one of these to handle the original call:
 - **Hold** button —Puts the first call on hold and dials the second.
 - **Transfer** button —Transfers the first party to the second and drops you from the call. To complete the action, press the **Transfer** button again after dialing.
 - **Conference** button —Creates a conference call with all parties, including you. To complete the action, press the **Conference** button again after dialing.
 - **End Call** softkey—Disconnects the first call and dials the second.

Personal Directory

The personal directory contains a list of your personal contacts. You can assign fast-dial codes to your personal directory entries for fast-dialing.

There are two ways you can set up and maintain your personal directory:

- **Phone**—Using your phone, you can:
 - Set up and use Personal Directory
 - Assign and use fast-dial codes
- **User Options Web Pages**—Using User Options web pages, you can also set up and use your personal directory.

Related Topics

[User Options, page 64](#)

Personal Directory Options

From your phone, you can use personal directory options to:

- Sign in and out
- Add an entry
- Search for an entry
- Dial a number
- Delete an entry
- Edit an entry

Sign In and Out of Personal Directory

1. Press the **Contacts** button .
2. Select **Personal Directory**. (Use the Navigation bar and button to scroll and select.)
3. Enter your user ID and PIN (provided by your system administrator), then press the **Submit** softkey.
4. Select the **Exit** softkey, twice, to sign out.

If you do not sign out, you are automatically signed out. For more information, see your system administrator.

Add a Personal Directory Entry



1. Sign in to **Personal Directory**.
2. Press the **New** softkey (you may need to press the **more** softkey first).
3. Enter the name information.
4. Press the **Phones** softkey and enter the phone numbers.
Include any required access codes such as a **9** or **1**.
5. Press the **Submit** softkey to add the entry to your personal directory.

Search for an Entry in Personal Directory

1. Sign in to **Personal Directory**.
2. Select **Personal Address Book**. (Use the Navigation bar and button to scroll and select.)

3. Choose any of the following criteria to search for an entry. (Use the Navigation bar and button to scroll and select.)
 - First name
 - Last name
4. Enter the search criteria information, then press the **Submit** softkey.
The name displays.
5. Press the **Select** softkey.

Dial a Number from Personal Directory

1. Sign in to **Personal Directory** and search for an entry. (Use the Navigation bar and button to scroll and select.)
2. Select the number that you want to dial.
3. To dial a contact, use one of these options:
 - Press the **Dial** softkey.
 - Press a line button.
 - Press the **Speakerphone** button .
 - Press the **Headset** button .
 - Pick up the handset.

Delete a Personal Directory Entry

1. Sign in to **Personal Directory** and search for an entry. (Use the Navigation bar and button to scroll and select.)
2. Press the **Edit** softkey.
3. Press the **Delete** softkey. (You may need to select the **more** softkey first.)
4. Press the **OK** softkey to confirm the deletion.

Edit a Personal Directory Entry

1. Sign in to **Personal Directory** and search for an entry. (Use the Navigation bar and button to scroll and select.)
2. Press the **Edit** softkey to modify the name or email address.
3. Modify the name or email address.
4. Press the **Phones** softkey to modify a phone number.
5. Press the **Update** softkey.

Fast-Dial Codes with Personal Directory

Using the phone, you can:

- Assign a fast-dial code to a Personal Directory entry
- Place a call using a fast-dial code
- Delete a fast-dial code

Assign a Fast-Dial Code to a Personal Directory Entry

1. Sign in to **Personal Directory**. (Use the navigation bar and button to scroll and select.)
2. Enter the name information and press the **Submit** softkey.
3. Select the name, then press the **FastDial** softkey.
4. Select a number and press the **Select** softkey.
5. Press the **Next** softkey.
6. Press the **Assign** softkey for a new fast-dial code that you want to assign to the number.

Place a Call Using a Fast-Dial Code

1. Sign in to **Personal Directory** and search for a fast-dial code. (Use the Navigation bar and button to scroll and select.)
2. Select the fast-dial code you want to dial.
3. Press the **Dial** softkey.

Delete a Fast-Dial Code

1. Sign in to **Personal Directory** and search for a fast-dial code. (Use the Navigation bar and button to scroll and select.)
2. Select the fast-dial code that you want to delete.
3. Press the **Remove** softkey.

Messages

Voice Messages

Voice messages are stored on your voicemail system. Your company determines the voicemail system your phone uses.

You can:

- Personalize your voicemail
- Check for voice messages
- Listen to voice messages

Personalize Your Voicemail

Press the **Messages** button , then follow the voice prompts.

Check for Voice Messages

Check for voice messages in any of these ways:

- Look at the visual message indicator lamp on your handset.
You can configure the visual message indicator lamp using your User Options web pages.
- Look for:
 - (For Cisco Unified IP Phone 6941 only.) A message waiting icon .
 - (For Cisco Unified IP Phones 6921 and 6961 only.) A text message.
- Listen for a stutter tone from your handset, headset, or speakerphone when you place a call.
The stutter tone is line-specific. You hear it only when using the line that has a waiting message.
You can configure the audible message indicator using your User Options web pages.

Related Topics

- [Change the Voice Message Indicator Setting Per Line, page 66](#)
- [Change the Audible Voice Message Indicator Setting Per Line, page 67](#)

Listen to Voice Messages

There are two ways you can listen to voice messages:

- Press the **Messages** button  to listen to voice messages left on any line.
- Press a line button, then press **Messages** to hear only the voice messages for that line.

Calling Features

Feature Buttons and Softkeys

Depending upon how your system administrator sets up your phone, some features included in this guide might not be available to you.

This table provides information about some of the features that are available on dedicated feature buttons, and some of the features that are set up by your system administrator either on programmable feature buttons or softkeys.

Feature Name	Dedicated Feature Button	Programmable Feature Button	Softkey
Call Back		X	X
Call Forward All		X	X
Call Park		X	X
Call Park Line Status		X	
Call Pickup		X	X
Call Pickup Line Status		X	
Conference	X		X
Directed Call Park		X	
Divert			X
Do Not Disturb (DND)		X	
Group Pickup		X	X
Hold	X		
Hunt Groups		X	
Intercom		X	
Malicious Call Identification (MCID)		X	
Meet Me		X	X
Mobile Connect		X	

Feature Name	Dedicated Feature Button	Programmable Feature Button	Softkey
Mute	X		
Other Pickup		X	X
Privacy		X	
Quality Reporting Tool (QRT)		X	
Redial		X	X
Speed Dial		X	X
Speed Dial Line Status		X	
Transfer	X		X

Auto Answer

Auto Answer prompts your phone to automatically answer incoming calls after one ring.

Your system administrator sets up Auto Answer to work with either your speakerphone or headset.

Auto Answer with Your Headset

Keep the headset button  illuminated when the phone is idle. Otherwise, calls ring normally and you must manually answer them.

To keep the headset button illuminated, use a line button or softkeys (instead of the headset button) to go off-hook and on-hook, and to place and end calls.

Auto Answer with Your Speakerphone

Keep the handset in the cradle and the headset button  unlit. Otherwise, calls ring normally and you must manually answer them.

Call Back

Call Back allows you to receive an audio and visual notification on your phone when a busy or unavailable party becomes available.

Set up a Call Back Notification

1. Press the **Callback** softkey while listening to the busy tone or ring sound.
A confirmation screen displays on the phone.
2. Press the **Exit** softkey to return to the main screen, if desired.
Your phone alerts you when the line is free.
3. Press the **Dial** softkey to place the call again, if desired.

Call Forward All

Call Forward All allows you to forward calls on your phone to another number.

For your primary line, you can set up Call Forward All directly on your phone. For all other lines—or to access Call Forward All remotely—go to your User Options web pages.

There are two types of call forwarding features that your system administrator might set up on your phone:

- Unconditional call forwarding (Call Forward All)—Applies to all calls that you receive.
- Conditional call forwarding (Call Forward No Answer, Call Forward Busy, Call Forward No Coverage)—Applies to certain calls that you receive, according to conditions, and is accessible only from your User Options web pages.

When forwarding calls from your phone:

- Enter the call forward target number exactly as you would dial it from your phone. For example, enter an access code or the area code, if necessary.
- Call forwarding is phone-line specific. If a call reaches you on a line where call forwarding is not enabled, the call will ring as usual.
- Your system administrator can set up other call forward options that:
 - Allow calls placed from the call forward target number to your phone to ring through, rather than be forwarded.
 - Prevent you from creating a call forward loop or exceeding the maximum number of links in a call forwarding chain.

Related Topics

[Set Up Call Forwarding Per Line, page 66](#)

Forward Calls on a Primary Line

1. Press the **Fwd All** softkey.
2. Enter the target phone number. (Depending on how your voicemail system is set up, you may be able to press the **Messages** button  to forward all calls to voicemail.)
Visual confirmation displays on your screen for as long as the feature is enabled.
3. To cancel call forwarding, press **Fwd OFF**.
To forward calls on other lines, go to your User Options Web pages.

Call Park

Call Park allows you to park (temporarily store) a call you receive on your phone, and which you can then retrieve from another phone (for example, a phone at a co-worker's desk or in a conference room).

There are two ways you can park a call:

- **Park**—Allows you to park an active call that you answered on your phone, and retrieve it using another phone in the Cisco Unified Communications Manager system.
- **Directed Call Park**—Allows you to park and retrieve an active call in two different ways:
 - **Assisted Directed Call Park**—Allows you to park an active call by pressing a line button, which your system administrator sets up as a speed dial line.
With this type of directed call, you can monitor the status of the line (in-use, idle, or in Do Not Disturb state) using Line Status indicators.
 - **Manual Directed Call Park**—Allows you to park an active call by transferring it to a Directed Call number, which your system administrator sets up.
You retrieve the call at another phone by dialing a park retrieval prefix number (provided by your system administrator), then dialing the Directed Call number you used to park the call.

Your system administrator sets up either the Directed Call Park or Park feature on your phone, but not both.

Related Topics

[Line Status, page 55](#)

Park and Retrieve a Call Using Park

1. During a call, press the **Park** softkey.
Your phone displays the call park number where the system stored your call.
2. Note the call park number displayed on your phone screen.
You will use the number to retrieve the call.
3. Hang up.
You have a limited time to retrieve a parked call before it reverts to ringing at the original number.
4. From any other Cisco Unified IP Phone in your network, enter the call park number to retrieve the call.

Park and Retrieve a Call Using Assisted Directed Call Park

1. During a call, press a **Directed Call Park** button displaying an idle Line Status indicator.
You have a limited time to retrieve the parked call before it reverts to ringing at the original number.
2. Retrieve the call, from any other Cisco Unified IP Phone in your network as follows:
 - a. Enter the park retrieval prefix.
 - b. Dial the Directed Call number.

For example, if the park retrieval prefix is “99” and the Directed Call number is “1234”, enter 991234.

Park and Retrieve a Call Using Manual Directed Call Park

1. During a call, press the **Transfer** button  .
2. Enter the Directed Call number where you will park the call.
3. Press **Transfer** again to finish parking the call, then hang up.
You have a limited time to retrieve a parked call before it reverts to ringing at the original number.
4. Retrieve the call, from any other Cisco Unified IP Phone in your network as follows:
 - a. Enter the park retrieval prefix.
 - b. Dial the Directed Call number.

For example, if the park retrieval prefix is “99” and the Directed Call number is “1234”, enter 991234.

Call Pickup

Call Pickup allows you to answer a call that is ringing on a co-worker's phone by redirecting the call to your phone.

You might use Call Pickup if you share call-handling tasks with co-workers.

There are three ways you can pick up a call:

- **Pickup**—Allows you to answer a call that is ringing on another phone within your call pickup group.
If multiple calls are available for pick up, your phone picks up the oldest call first (the call that has been ringing for the longest time).
- **Group Pickup**—Allows you to answer a call on a phone that is outside your call pickup group by:
 - Using a group pickup number (provided by your system administrator).
 - Dialing the ringing phone's number.
- **Other Pickup**—Allows you to answer a call that is ringing on another phone within in your call pickup group or in an associated call pickup group.

Your system administrator sets up the call pickup group you are in, and the call pickup softkeys depending on your call-handling needs and work environment.

You can also monitor and pick up ringing calls using Line Status indicators if your system administrator has set up Line Status indicators on speed-dial buttons for you. Line Status indicators allow you to see if a line associated with a speed-dial button is idle, in-use, in a Do Not Disturb state, or ringing.

Related Topics

[Line Status, page 55](#)

Answer a Call Using Pickup

1. Press the **PickUp** softkey to transfer a ringing call within your pickup group to your phone.
If you have multiple lines and want to pick up the call on a non-primary line, first press the desired line button, then press **PickUp**.
If your phone supports auto-pickup, you are connected to the call.
2. If the call rings, press the **Answer** softkey to connect to the call.

Answer a Call Using Group Pickup and a Group Pickup Number

1. Press the **GPickup** softkey to answer a call on a phone outside your pickup group.
If you have multiple lines and want to pick up the call on another line, first press the desired line button, then press **GPickup**.

2. Enter the group pickup number.
If your phone supports auto-pickup, you are now connected to the call.
3. If the call rings, press the **Answer** softkey to connect to the call.

Answer a Call Using Group Pickup and a Phone Number

1. Press the **GPickup** softkey.
If you have multiple lines and want to pick up the call on a non-primary line, first press the desired line button, then press **GPickup**.
2. Enter the number of the phone line with the call that you want to pick up. For example, if the call is ringing on line 12345, enter 12345.
If your phone supports auto-pickup, you are now connected to the call.
3. If the call rings, press the **Answer** softkey to connect to the call.

Answer a Call Using Other Pickup

1. Press the **OPickup** softkey to transfer a call in your pickup group or in an associated group to your phone.
If your phone supports auto-pickup, you are now connected to the call.
2. If the call rings, press the **Answer** softkey to connect to the call.

Call Waiting

Call Waiting provides cues to notify you that a new call is ringing on your phone when you are talking on another call, including:

- A call waiting tone (single beep)
- An amber flashing line button

Respond to a Call Waiting Notification

(Your system administrator must set up multiple lines on your phone before you can use this feature.)

To answer the ringing call, press the flashing amber line button. Your phone puts the original call on hold automatically and connects the ringing call.

Codes

Codes allow you to place a call using a billing or tracking code. Your phone supports two types of codes (provided by your administrator):

- Client Matter Codes (CMC) require you to enter a code to specify that the call relates to a specific client matter. Your administrator can assign client matter codes to customers, students, or other populations for call accounting and billing purposes.
- Forced Authorization Codes (FAC) allow you to manage call access and accounting. The Forced Authorization Codes feature requires that the user enter a valid authorization code before the call connects.

Place a Call Using a Client Matter Code

1. Dial a number.
2. After the tone, enter a client matter code (CMC).

Place a Call Using a Forced Authorization Code

1. Dial a number.
2. After the tone, enter a forced authorization code (FAC).

Conference

Conference allows you to talk simultaneously with multiple parties.

When you are talking on a call, use Conference to dial another party and add them to the call.

If you have multiple phone lines, you can alternately use Conference to combine two calls across two lines. For example, if you have a call on Line 1 and a call on Line 2, you can combine the calls into a conference.

Before completing a conference procedure, you can press the **Cancel** softkey to cancel the procedure or you can press the **Swap** softkey to toggle between calls, allowing you to speak privately with each party.

As the conference host, you can remove individual participants from the conference.

The conference ends when all the participants hang up.

Add Another Party to Your Call to Create a Conference

1. Verify that you are on an active call (not on hold).
2. Press the **Conference** button .
3. Enter the phone number for the party you want to add (or press a speed-dial button).
4. Wait for the party to answer (or skip to step 5 while the call is ringing).
5. Press the **Conference** button again.
The conference begins.
Repeat these steps to add more parties, if desired.

Combine Calls Across Lines to Create a Conference

This task requires multiple phone lines.

1. Verify that you have two connected calls and that one of the calls is active (not on hold).
2. Press the **Conference** button .
3. Press the line button for the other (held) call.
The conference begins. (The conference is established on the line with the active call.)

Swap Between Calls Before Completing a Conference

After calling a new conference participant, but before adding the participant to the conference, press the **Swap** softkey to toggle between the two calls. This allows you to consult privately with the party or parties on each call before combining the calls into a conference.

End a Conference

The conference ends when all participants hang up.

View Conference Participants

While in a conference, press the **Details** softkey to view a list of participants.

Remove Conference Participants

1. While in a conference, press the **Details** softkey to view a list of participants.
2. Highlight the participant that you want to remove, then press the **Remove** softkey.

Divert

Divert allows you to send an active or ringing call to your voicemail system or to a predetermined phone number (set up by your system administrator).

Divert a Call

Press the **Divert** softkey to send an active, ringing, or held call to your voicemail system or to a predetermined phone number (set up by your system administrator).

Do Not Disturb

Do Not Disturb (DND) allows you to turn off either the ringer on your phone, or the ringer and any other audible or visual notification that you have an incoming call.

When the ringer and notifications are turned off, the call is sent directly to your voicemail system.

Your system administrator sets up a line button on your phone for DND, but you can change your DND options from your User Options web pages.

DND interacts with other types of calls:

- If both DND and Call Forward All are enabled, calls are forwarded without any visual or audible confirmation.
- DND does not affect intercom calls or non-intercom priority calls.
- If both DND and auto-answer are enabled, only intercom calls are auto-answered.

Related Topics

[User Options, page 64](#)



Turn DND On and Off

1. Press the **DND** button to turn on DND.
Visual confirmation displays briefly.
2. Press the button again to turn off DND.
Visual confirmation displays briefly.

Extension Mobility

Cisco Extension Mobility (EM) allows you to temporarily configure a Cisco Unified IP Phone as your own. After you sign in to EM, the phone adopts your user profile, including your phone lines, features, established services, and web-based settings. Your system administrator sets up EM for you.

Enable Extension Mobility

1. Press the **Applications** button  .
2. Select **Services**. (Use the Navigation bar and button to scroll and select.)
3. Select **EM Service** (name can vary).
4. Enter your user ID and PIN (provided by your system administrator).
5. If prompted, select a device profile.
6. To sign out, press the **Applications**  button.
7. Select **Services**.
8. Select **EM Service** (name can vary).
9. When prompted to sign out, press the **Yes** softkey.

Fast Dial

Fast Dial allows you dial a phone number from the Fast Dial service on your phone. Before you can use Fast Dial on your phone, you must set up Fast Dial on your User Options Web pages.

Related Topics

[Fast Dials, page 73](#)

Place a Call with a Fast-Dial Button



(Before you can use Fast Dial on your phone, you must set up Fast Dial on your User Options Web pages.)

1. Press the Fast-Dial button.
2. Sign in to Personal Directory.
3. Select **Personal Fast Dials**.
4. Select a fast-dial code and then press the **Dial** softkey.

Hold

Hold allows you to put an active call into a held state.

Hold and Resume a Call

1. To put a call on hold, press the **Hold** button .
The Hold icon  displays and the line button flashes green.
2. To resume the call, press the **Resume** softkey or the flashing green line button.

Swap Between Held and Active Calls on Multiple Lines

If your phone supports multiple lines, use line buttons to swap between held and active calls.

For example, if you have a held call on Line 1 and an active call on Line 2, press the Line 1 button to make the Line 1 call active (resume it from hold) and to automatically put the Line 2 call on hold.

Put a Call on Hold by Answering a New Call on Another Line

If your phone supports multiple lines, and you are already on a call when a new call rings, answering the new call puts the first call on hold automatically.

To answer the new call in this case, press the flashing amber line button or the **Answer** softkey.

Determine if a Shared Line is on Hold

Look for a flashing red line button and the hold icon . When these indicators display, a call on the shared line has been put on hold remotely by the other user.

Hold Reversion

Hold Reversion notifies you when a call is left on hold.

A Hold Reversion notification is similar to a new call notification and includes these cues:

- Single ring, repeating at intervals
- Flashing amber line button
- Flashing message indicator on the handset
- Visual notification on the phone screen

Respond to a Hold Reversion Notification

Press the flashing amber line button or the **Answer** softkey to resume the call from hold.

Hunt Groups

Hunt groups are used to share the call load in organizations that receive a large number of incoming calls.

Your system administrator sets up a hunt group with a series of directory numbers. When the first directory number in the hunt group is busy, the system hunts for the next available directory number in the group, then directs the call to that phone.

If you are a member of a hunt group, you can sign in to a hunt group when you want to receive calls, and you can sign out of the group when you want to prevent calls from ringing on your phone.

Sign In and Out of a Hunt Group

1. Press the **Hunt Group** button to sign in.
Visual confirmation displays briefly.
2. Press the button again to sign out.
Signing out of a hunt group does not prevent non-hunt group calls from ringing your phone.

Intercom

Intercom allows you to place and receive one-way calls using a dedicated intercom line.

When you place an intercom call, the recipient's phone auto-answers with mute activated (*whisper*) and broadcasts your message through the recipient's speakerphone—or through the headset or handset, if one of these devices is active.

After receiving the intercom call, the recipient can initiate two-way audio (*connected*) to continue the call.

Place an Intercom Call

1. Press the **Intercom** button.
If your phone auto-dials the intercom code, begin speaking after the alert tone. Otherwise, go to Step 2.
2. Enter the intercom code and begin speaking after the alert tone.

Receive an Intercom Call

When you receive an intercom call, you hear an intercom-alert tone and your phone auto-answers the call. Any current call activity that you are engaged in continues simultaneously, but the intercom caller cannot hear you.

To speak to the intercom caller, press the active **Intercom** button.





Line Status

Line Status indicators allow you to view the state of a phone line that is associated with a speed-dial button.

Your system administrator sets up Line Status indicators on your phone.

Line Status Indicators

Line Status indicators show the state of a line.

Icon	Indicator
	Line is in use.
	Line is idle.
	Line is in Do Not Disturb (DND) state.
	Line is ringing. (Only for Call Pickup.)

Line Status indicators can be set up on speed dial buttons by your system administrator, and can be used with these features:

- **Speed Dial**—Allows you to monitor the status of (and dial) a specific number on a speed-dial button.
- **Call Park**—Allows you to monitor the line status of (and dial) an Assisted Directed Call Park number on a speed-dial button.
- **Call Pickup**—Allows you to monitor the line status of (and pick up a ringing call on) a speed-dial button.

Your system administrator can also set up your phone to play an audible alert when a call is ringing on the monitored line

Related Topics

- [Speed Dial, page 60](#)
- [Call Park, page 45](#)
- [Call Pickup, page 47](#)

Malicious Call Identification

Malicious Call Identification (MCID) allows you to identify an active call as suspicious, which initiates a series of automated tracking and notification messages.

Trace a Suspicious Call

Press the **Malicious Caller ID** button to send a silent notification message to your system administrator. When the silent notification message is sent, your phone provides both a visual and audible confirmation.

Meet Me

Meet Me allows you to call a predetermined number at a scheduled time to host or join a conference. The conference begins when the host connects. Participants who call the conference before the host has joined hear a busy tone and must dial again.

The conference ends when all participants hang up; the conference does not automatically end when the host disconnects.

Host a Meet-Me Conference

1. Obtain a Meet-Me phone number from your system administrator.
2. Distribute the Meet-Me phone number to participants.
3. When you are ready to start the meeting, go off-hook to get a dial tone, then press the **Meet Me** softkey.
4. Dial the Meet-Me phone number.

Join a Meet-Me Conference

Dial the Meet-Me phone number (provided by the conference host).

If you hear a busy tone, the host has not yet joined the conference. In this case, try your call again.

Mobile Connect

Mobile Connect allows you to use your mobile phone to handle calls associated with your desk phone number.

To set up Mobile Connect, use the User Options web pages to set up remote destinations and create access lists to allow or block calls from specific phone numbers from being passed to the remote destinations.

When you enable Mobile Connect:

- Your desk phone and remote destinations receive calls simultaneously.
- When you answer the call on your desk phone, the remote destinations stop ringing, are disconnected, and display a missed call message.
- When you answer the call on one remote destination, the other remote destinations and desk phone stop ringing, are disconnected, and a missed call message is shown on the other remote destinations.

Related Topics

- [Create an Access List, page 76](#)
- [Add a New Remote Destination, page 75](#)

Turn On or Off Mobile Connect to All Your Remote Destinations From Your Desk Phone

1. Press the **Mobility** button to display the current remote destination status (Enabled or Disabled).
2. Press the **Select** button to change the status.
3. Press the **Exit** softkey.

Related Topics

[Add a New Remote Destination, page 75](#)

Switch an In-Progress Call on Your Desk Phone to a Mobile Phone

1. Press the **Mobility** button.
2. Select **Send call to mobile**.
3. Answer the in-progress call on your mobile phone.

The desk phone line button turns red and handset icons and the calling party number appear on the phone display. You cannot use the same phone line for any other calls, but if your desk phone supports multiple lines, you can use another line to make or receive calls.

Switch an In-Progress Call From a Mobile Phone to Your Desk Phone

1. Select a line on your desk phone.
2. Hang up the call on your mobile phone to disconnect the mobile phone, but not the call.
3. Press the **Resume** softkey on your desk phone within five to 10 seconds and start talking on the desk phone.

Mute

Mute allows you to block audio input for your handset, headset, and speakerphone, so that you can hear other parties on the call but they cannot hear you.

Mute Your Phone

1. Press the **Mute** button  to turn Mute on.
Visual confirmation displays.
2. Press the **Mute** button again to turn Mute off.

On-hook Dialing

On-hook dialing allows you to enter a phone number before getting a dial tone and to complete the call by going off-hook.

Dial a Number On-hook

1. Enter or speed-dial a phone number.
2. Go off-hook.

Privacy

Privacy allows you to prevent others who share your line from seeing information about your calls.

Privacy applies to all shared lines on your phone. If you have multiple shared lines and Privacy is enabled, others cannot view any of your shared lines.

If the phone that shares your line has Privacy enabled, you can make and receive calls using the shared line as usual.

Related Topics

[Shared Lines, page 60](#)

Enable Privacy on a Shared Line

1. Press the **Privacy** button to enable the feature.
Visual confirmation displays on your phone screen for as long as the feature is enabled.
2. Press the button again to turn off the feature.

Quality Reporting Tool

Your system administrator may temporarily configure your phone with the Quality Reporting Tool (QRT) to troubleshoot performance problems. Depending on configuration, use the QRT to:

- Immediately report an audio problem on a current call.
- Select a general problem from a list of categories and choose reason codes.

Report Problems on Your Phone

1. Press the **Quality Reporting Tool** button.
2. Select the item that most closely matches your problem. (Use the Navigation pad and Select button to scroll and select.)
3. Press the **Select** softkey.
The information is sent to your system administrator.

Redial

Redial allows you to call the most recently dialed phone number by pressing a button.

Redial a Number

Press the **Redial** softkey.

To place the call on a particular phone line, get a dial tone on that line, then press the **Redial** softkey.

Shared Lines

Shared lines allow you to use one phone number for multiple phones.

You might have a shared line if you have multiple phones and want one phone number, share call-handling tasks with co-workers, or handle calls on behalf of a manager.

For example, if you share a line with a co-worker:

- When a call comes in on the shared line:
 - Your phone rings and the line button flashes amber.
 - Your co-worker's phone rings and the line button flashes amber.
- If you answer the call:
 - Your line button turns green.
 - Your co-worker's line button turns red.
When button is red, that line cannot be used to barge in on the call or used to make another call.
- If you put the call on hold:
 - Your line button flashes green
 - Your co-worker's line button flashes red.
When the line flashes red, your co-worker can pick up the call.

Speed Dial

Speed-dial features allow you to place a call by pressing a button, entering a code, or selecting an item from the Call History list. Before you can use speed-dial features on your phone, you must set up speed-dial on your User Options Web pages.

Depending on setup, your phone can support these speed-dial features:

- Speed-Dial Buttons—Allow you to quickly dial a phone number from one or more line buttons set up for speed dialing.
- Speed-Dial Codes—Allow you to dial a phone number from a code (sometimes referred to as abbreviated dialing).

If your system administrator has set up the Line Status feature, you can monitor the status of a speed-dial line by using the line status indicators.

Related Topics

- [Speed Dial on the Web, page 68](#)
- [Line Status Indicators, page 55](#)

Place a Call with a Speed-Dial Button

(Before you can use speed-dial buttons on your phone, you must set up speed dial on your User Options Web pages.)

To place a call, press a speed-dial button .

Place a Call with a Speed-Dial Code

(Before you can use speed-dial codes on your phone, you must set up the codes on your User Options Web pages.)

To place a call, enter the speed-dial code and press the **SpeedDial** softkey.

Transfer

Transfer allows you to redirect a connected call from your phone to another number.

You can use *Transfer* or *Direct Transfer*:

- Transfer allows you to redirect a single call to another number that you specify.
- Direct Transfer allows you to connect two calls on two different lines to each other (without remaining on the line yourself).

Before completing a transfer procedure, you can press the **Cancel** softkey to cancel the procedure or you can press the **Swap** softkey to toggle between calls, allowing you to speak privately with each party.

Transfer a Call to Another Number

1. Verify that you are on an active call (not on hold).
2. Press the **Transfer** button .
3. Enter the transfer recipient's phone number (or press a speed dial button).
4. Wait for the recipient to answer. (Or, skip to Step 5 while the call is ringing.)
5. Press the **Transfer** button again.

The transfer is complete.

Use Direct Transfer to Connect Calls Across Lines

This task requires multiple phone lines.

1. Verify that you have two connected calls and that one of the calls is active (not on hold).
2. Press the **Transfer** button .
3. Press the line button for the other (held) call.

The transfer completes (the two calls are connected to each other).

Swap Between Calls Before Completing a Transfer

After you connect to the transfer recipient—but before you transfer a call to this party—you can press the **Swap** softkey to toggle between the two calls. This allows you to consult privately with the party on each call before you complete the transfer.

Web Dialer

Web Dialer allows you to click-to-dial contacts from the Cisco Unified CM Directory. Your system administrator sets up this feature for you.

Use Web Dialer with Cisco Directory

1. Sign in to your User Options web pages.
2. Select **User Options > Directory** and search for a co-worker.
3. Select the number that you want to dial.
4. If this is your first time using Web Dialer, review the preferences on the Make Call page.
5. Select **Dial**.

The call is now placed on your phone.

6. To end a call, select **Hang up** or hang up from your phone.

Use Web Dialer with Another Online Corporate Directory

1. Sign in to a Web Dialer-enabled corporate directory and search for co-workers.
2. Select the number that you want to dial.
3. When prompted, enter your user ID and password.
4. If this is your first time using Web Dialer, review the preferences on the Make Call page.

5. Select **Dial**.

The call is now placed on your phone.

6. To end a call, select **Hang up** or hang up from your phone.

Set Up, View, or Change Web Dialer Preferences

1. Initiate a call using Web Dialer to access the Make Call page.

The Make Call page displays the first time that you use WebDialer (after you select the number that you want to dial).

2. Select one of the following options from the Make Call page:

- Preferred language—Determines the language used for Web Dialer settings and prompts.
- Use preferred device—Identifies the Cisco Unified IP Phone (Calling device) and directory number (Calling line) that you will use to place Web Dialer calls. If you have one phone with a single line, the appropriate phone and line are automatically selected. Otherwise, choose a phone and/or line. If you have more than one phone of the same type, it will be specified by device type and MAC address. (To display the MAC address on your phone, select the **Applications** button  > **Phone Information**.)

If you have an Extension Mobility profile, you can select Extension Mobility from the Calling Device drop-down menu from the Make Call page.

- Do not display call confirmation—If selected, the Web Dialer Make Call page will not display the next time Web Dialer is used. Calls will automatically be dialed after clicking on a contact from the Cisco Directory.
- Disable Auto Close—If selected, the call window does not close automatically after fifteen seconds.

Sign Out of Web Dialer

Select the sign out icon  in the Make Call or Hang Up page.

User Options

User Options Web Pages

Your Cisco Unified IP Phone is a network device that can share information with other network devices in your company, including your personal computer.

You can use your computer to sign in to your Cisco Unified CM User Options web pages, where you can control features, settings, and services for your Cisco Unified IP Phone. For example, you can set up speed-dial buttons from your User Options web pages.

After you have signed in to your User Options web pages, select User Options to access the following:

- Device
- User Settings
- Directory
- Personal Address Book
- Fast Dials
- Mobility Settings
- Plugins

Related Topics

- [Contacts, page 35](#)
- [Call Forward All, page 44](#)

Sign In and Out of User Options Web Pages

Before you can access any of your user options, such as speed-dial settings or personal address book, you must sign in. When you are finished using the user options web pages, you must sign out.

1. Obtain the User Options URL, user ID, and default password (provided by your system administrator).
2. Open a web browser on your computer and enter the URL.
3. If prompted to accept security settings, select **Yes** or **Install Certificate**.
4. Enter your userid in the Username field.
5. Enter your password in the Password field.

6. Select Login.

The Cisco Unified CM User Options home page displays. From this page you can select User Options to select a device, access User Settings, Directory features, your Personal Address Book, and Fast Dials.

7. To sign out of user options, select Logout.

Device

You can make changes to your device settings on your phone from the User Options web pages. You can make changes to these device settings on your phone:

- Do not disturb options
- Line settings
- Speed dials
- Phone services

Related Topics

[Speed Dial, page 60](#)

Select a Device From the User Options Web Pages

1. After you have signed in to your User Options web pages, select **User Options > Device.**

The Device Configuration page displays. Toolbar buttons located at the top of the Device Configuration page are specific to the selected device type.

2. If you have multiple devices assigned to you, select the appropriate device (phone model, Extension Mobility profile, or Remote Destination profile) from the Name drop-down menu.

Customize Do Not Disturb Options

1. Sign in to your User Options web pages. Your system administrator sets up the Do Not Disturb (DND) feature for your phone.**2. From the drop-down menu, select **User Options > Device**.****3. Set the following options:**

- Do Not Disturb—Check the check box to enable or disable DND.
- DND Option—Select either None or Ringer Off (to turn off only the ringer).
- DND Incoming Call Alert (applies to either DND option set)—Set the alert to Beep Only, Flash Only, Disable, or select “None” (to use the “Alert” setting set up by your system administrator).

Related Topics

[Do Not Disturb, page 51](#)

Line Settings

Line settings affect a specific phone line (directory number) on your phone. Line settings can include call forwarding, visual and audio message-waiting indicators, voice-message indicators, ring patterns, and other line-specific settings.

You can set up other line settings directly on your phone:

- Set up call forwarding for your primary phone line
- Change rings, display, and other phone-model specific settings

Related Topics

- [Call Forward All, page 44](#)
- [Ring Tones, page 32](#)

Set Up Call Forwarding Per Line

1. Sign in to your User Options web page.
2. Select **User Options > Device**.
3. Select a phone from the Name drop-down menu.
4. Select **Line Settings**.
5. If you have more than one directory number (line) assigned to your phone, select a line from the Line drop-down menu.
6. In the Incoming Call Forwarding area, select call forwarding settings for various conditions.
7. Select **Save**.

Related Topics

[Call Forward All, page 44](#)

Change the Voice Message Indicator Setting Per Line

1. Sign in to your User Options web page.
2. Select **User Options > Device**.
3. Select a phone from the Name drop-down menu.
4. Select **Line Settings**.
5. If you have more than one directory number (line) assigned to your phone, select a line from the Line drop-down menu.

6. In the Message Waiting Lamp area, choose from various settings. Typically, the default message waiting setting prompts your phone to display a steady red light from the handset light strip to indicate a new voice message.
7. Select **Save**.

Change the Audible Voice Message Indicator Setting Per Line

1. Sign in to your User Options web page.
2. Select **User Options > Device**.
3. Select a phone from the Name drop-down menu.
4. Select **Line Settings**.
5. If you have more than one directory number (line) assigned to your phone, select a line from the Line drop-down menu.
6. In the Audible Message Waiting Lamp area, choose from various settings.
7. Select **Save**.

Change the Ring Settings Per Line

1. Sign in to your User Options web page.
2. Select **User Options > Device**.
3. Select a phone from the Name drop-down menu.
4. Select **Line Settings**.
5. If you have more than one directory number (line) assigned to your phone, select a line from the Line drop-down menu.
6. In the Ring Settings area, set the option for Ring Setting (Phone Idle) and Ring Setting (Phone Active) from the drop-down menus. The options are:
 - Use System Default
 - Disable
 - Flash Only
 - Ring Once
 - Ring
 - Beep Only [this option is only available for Ring Setting (Phone Active)]
7. Select **Save**.

Change or Create a Line Text Label for Your Phone Display

1. Sign in to your User Options web page.
2. Select **User Options > Device**.

3. Select a phone from the Name drop-down menu.
4. Select **Line Settings**.
5. If you have more than one directory number (line) assigned to your phone, select a line from the Line drop-down menu.
6. In the Line Text Label area, enter a text label.
7. Select **Save**.

Speed Dial on the Web

Depending on how your phone has been set up, you can use speed-dial buttons and speed-dial codes, which you can set up on your User Options Web pages.

Set Up Speed-Dial Buttons

1. Sign in to your User Options Web pages.
2. Select **User Options > Device**.
3. Select a phone from the Name drop-down menu.
4. Select **Speed Dials**.
5. In the Speed Dial Settings area, enter a number and label for a speed-dial button on your phone.
6. Select **Save**.

Set Up Speed-Dial Codes

1. Sign in to your User Options Web pages.
2. Select **User Options > Device**.
3. Select a phone from the Name drop-down menu.
4. Select **Speed Dials**.
5. In the Abbreviated Dial Settings area, enter a number and label for a speed-dial code.
6. Select **Save**.

Phone Services

Phone services can include special phone features, network data, and web-based information (such as stock quotes and movie listings). You must first subscribe to a phone service before accessing it on your phone. You can subscribe, search, or assign a service to a speed-dial button from the User Options web page.

The services available for your phone depend on how the system administrator set up the phone system and which services you are subscribed to. For more information, see your system administrator.

If only one service is set up, the service opens by default. If more than one service is set up, select an option from the menu on the phone display.

Select a service by using one of these feature buttons:

 (a feature button that your system administrator sets up)

 Messages

 Application

 Contacts

Subscribe to a Service

1. Sign in to your User Options web page.
2. Select **User Options > Device**.
3. Select a phone from the Name drop-down menu.
4. Select **Phone Services**.
5. Select **Add New**.
6. Select a service from the drop-down list and select **Next**.
7. Change the service label and/or enter additional service information, if available (optional).
8. Select **Save**.

Search for Services

1. Sign in to your User Options web page.
2. Select a device.
3. Select **Phone Services**.
4. Select **Find**.

Change or End Services

1. Sign in to your User Options web page.
2. Search for services.
3. Select one or more entries.
4. Select **Delete Selected**.

Change a Service Name

1. Sign in to your User Options web page.
2. Search for services.
3. Select a service name.
4. Change the information and select **Save**.

Add a Service to an Available Programmable Feature Button

1. Sign in to your User Options web page.
2. Select **User Options > Device**.
3. Select a phone from the Name drop-down menu.
4. Select **Service URL**. Your system administrator sets up a service URL button for your phone.
5. Select a service from the Button Service drop-down list.
6. If you want to rename the service, edit the label fields.
7. Select **Save**.
8. Select **Reset** to reset your phone (necessary to see the new button label on your phone).

User Settings

Your PIN and password allow you to access different features and services. For example, use your PIN to sign in to Cisco Extension Mobility or Personal Directory on your phone. Use your password to sign in to your User Options web pages and Cisco Web Dialer on your personal computer. For more information, see your system administrator.

User settings include your browser password, PIN, and language (locale) settings.

Change Your Browser Password

1. Sign in to your User Options web pages.
2. Select **User Options > User Settings**.
3. Enter your Current Password.
4. Enter your New Password.
5. Reenter your new password in the Confirm Password field.
6. Select **Save**.

Change Your PIN

1. Sign in to your User Options web pages.
2. Select **User Options > User Settings**.
3. Enter your Current PIN.
4. Enter your New PIN.
5. Reenter your new PIN in the Confirm PIN field.
6. Select **Save**.

Change the Language for Your User Options Web Pages

1. Sign in to your User Options web page.
2. Select **User Options > User Settings**.
3. In the User Locale area, select an item from the Locale drop-down list.
4. Select **Save**.

Change the Language for Your Phone Display

1. Sign in to your User Options web page.
2. Select **User Options > Device**.
3. Select an item from the User Locale drop-down list.
4. Select **Save**.

Directory

To get a list of co-workers in your corporate directory, select **User Options > Directory**.

The Directory features that you can access on your computer consist of:

- Personal Address Book (PAB), which can also be accessed from your phone
- Fast Dials, which can also be accessed from your phone
- Cisco Unified Communications Manager Address Book Synchronizer

Related Topics

- [Personal Directory, page 36](#)
- [Corporate Directory, page 35](#)

Personal Address Book

You can add, delete, or update personal address book entries from the User Options web page.

Add a New PAB Entry

1. Sign in to your User Options web page.
2. Select **User Options > Personal Address Book**.
3. Select **Add New**.
4. Enter information for the entry.
5. Select **Save**.

Search for a PAB Entry

1. Sign in to your User Options web page.
2. Select **User Options > Personal Address Book**.
3. Specify search information and select **Find**.

Edit a PAB Entry

1. Sign in to your User Options web page.
2. Search for a PAB entry.
3. Select a nickname.
4. Edit the entry as needed and select **Save**.

Delete a PAB Entry

1. Sign in to your User Options web page.
2. Search for a PAB entry.
3. Select one or more entries.
4. Click **Delete Selected**.

Assign a Feature Button for Personal Address Book

1. Sign in to your User Options web page.

2. Select **User Options > Device**.
3. Select a phone from the Name drop-down menu.
4. Select **Service URL**.
Your system administrator sets up your phone to display services. For more information, see your system administrator.
5. Select the Personal Address Book service from the Button drop-down list box.
6. Enter a phone label for the button.
7. Select **Save**.
8. Select **Reset** and then select **Restart** to refresh the phone configuration.

You can now press the button to access PAB codes.

Fast Dials

You can add, delete, or update fast dial entries from the User Options web page.

You can create up to 500 Fast Dial and PAB entries. You can create a new Fast Dial entry without using a PAB entry. Such Fast Dial entries are labeled “raw” in the User Options web pages and do not display a configurable text label.

Assign a Feature Button for Fast Dial

1. Sign in to your User Options web page.
2. Select **User Options > Device**.
3. Select **Service URL** (provided by your system administrator).
4. Select the Fast Dial service from the Button drop-down list box.
5. Enter a phone label for the button.
6. Select **Save**.
7. Select **Reset** and then select **Restart** to refresh the phone configuration.

Assign a Fast Dial Code to a PAB Entry

1. Sign in to your User Options web page.
2. Select **User Options > Fast Dials**.
3. Select **Add New**.
4. Use the Search Options area to find the appropriate PAB entry.
5. Select a phone number in the Search Results area.

6. Change the Fast Dial code, if desired.
7. Select **Save**.

Assign a Fast Dial Code to a Phone Number Without Using a PAB Entry

1. Sign in to your User Options web page.
2. Select **User Options > Fast Dials**.
3. Select **Add New**.
4. Change the Fast Dial code, if desired.
5. Enter a phone number.
6. Select **Save**.

Search for a Fast Dial Entry

1. Sign in to your User Options web page.
2. Select **User Options > Fast Dials**.
3. Specify search information and select **Find**.

Edit a Fast Dial Phone Number

1. Sign in to your User Options web page.
2. Select **User Options > Fast Dials**.
3. Search for the Fast Dial entry that you want to edit.
4. Select a component of the entry.
5. Change the phone number.
6. Select **Save**.

Delete a PAB Entry

1. Sign in to your User Options web page.
2. Search for a Fast dial entry.
3. Select one or more entries.
4. Select **Delete Selected**.

Mobility Settings

When using Cisco Mobile Connect, you must add your mobile and other phones that you want to use to make and receive calls using the same directory numbers as your desk phone. These phones are called *remote destinations*. You can also define access lists to restrict or allow calls from certain numbers to be sent to your mobile phone.

Related Topics

[Mobile Connect, page 57](#)

Add a New Remote Destination

1. Sign in to your User Options web page.
2. Select **User Options > Mobility Settings > Remote Destinations**.
3. Select **Add New**.
4. Enter the following information:
 - Name—Enter a name for the mobile (or other) phone.
 - Destination Number—Enter your mobile phone number.
5. Select your remote destination profile from the drop-down list box. Your remote destination profile contains the settings that apply to remote destinations that you create.
6. Select the Mobile Phone check box to allow your remote destination to accept a call sent from your desk phone.
7. Select the Enable Mobile Connect check box to allow your remote destination to ring simultaneously with your desk phone.
8. Select one of the following options in the Ring Schedule area (the ring schedule drop-down list boxes include only the access lists that you have created):
 - All the time—Select this option if you do not want to impose day and time restrictions on ringing the remote destination.
 - As specified below—Select this option and select from the following items to set up a ring schedule based on day and time:
 - a. Select a check box for each day of the week you want to allow calls to ring the remote destination.
 - b. For each day, select All Day or select the beginning and ending times from the drop-down lists.
 - c. Select the time zone from the drop-down list box.
9. Select one of these ringing options:
 - Always ring this destination.
 - Ring this destination only if the caller is in the allowed access list that you select.

- Do not ring this destination if the caller is in the blocked access list that you select.

10. Select **Save**.

Create an Access List

1. Sign in to your User Options web page.
2. Select **User Options > Mobility Settings > Access Lists**.
3. Select **Add New**.
4. Enter a name to identify the access list and a description (optional).
5. Select whether the access list will allow or block specified calls.
6. Select **Save**.
7. Select **Add Member** to add phone numbers or filters to the list.
8. Select an option from the **Filter Mask** drop-down list box. You can filter a directory number, calls with restricted caller ID (Not Available), or calls with anonymous caller ID (Private).
9. If you select a directory number from the **Filter Mask** drop-down list box, enter a phone number or filter in the **DN Mask** field. You can use the following wild cards to define a filter:
 - **X** (upper or lower case)—Matches a single digit. For example, 408555123X matches any number between 4085551230 and 4085551239.
 - **!**—Matches any number of digits. For example, 408! matches any number starts with 408.
 - **#**—Used as a single digit for exact match.
10. To add this member to the access list, select **Save**.
11. To save the access list, select **Save**.

Plugins

Plugins on your User Options web pages allow you to download and access applications that your system administrator sets up for you.

For more information, see your system administrator.

Access Plugins

1. Sign in to your User Options web page.
2. Select **User Options > Plugins**.

You can view plugins only if your system administrator has set them up for you.

FAQs and Troubleshooting

Frequently Asked Questions

Q. Why don't I see the icons shown in the documentation on my phone screen?

A. Many of the phone screen icons are applicable only to the Cisco Unified IP Phone 6941.

Q. Can I use the second line on my Cisco Unified IP Phone 6921 as a feature button?

A. Yes. If you do not require two phone lines, your system administrator can set up a feature on your second line.

Q. When I put a call on hold by pushing the Hold button, why doesn't pushing the button again resume the call?

A. The Hold button is only used to put a call on hold. To resume a call, press the **Resume** softkey or the flashing green line button.

Troubleshooting Tips

Troubleshooting tips are available for these topics:

- Conference
- Personal Directory
- Shared Lines
- User Options

Conference

Problem: Conference Button and Softkey Unresponsive

You have set up a conference call, and the **Conf** softkey is no longer available and the Conference button is unresponsive.

Possible Cause

You have reached the maximum number of conference participants.

Solution

Ask one of the participants to drop, or drop a conference participant.

Problem: Meet-Me Conference Busy Tone

You hear a busy tone after dialing into a Meet-Me conference.

Possible Cause

The conference host has not yet joined the conference.

Solution

Try calling back again.

Personal Directory

Problem: Cannot Sign In to Personal Directory

You are unable to sign in to your personal directory.

Make sure you are using your personal identification number (PIN) to sign in, and not your password.

Possible Cause

Your PIN needs to be reset.

Solution

See your system administrator.

Shared Lines

Problem: No Caller ID on Remote Hold

You have a shared line on your Cisco Unified IP Phone 6921, and cannot see the caller ID when the remote line is on hold.

Possible Cause

This works as designed.

Solution

None.

User Options

Problem: Cannot Access User Options Web Pages

You are unable to access your user options web pages.

Possible Cause

Your password needs to be reset.

Solution

See your system administrator.

Product Safety, Security, Accessibility, and Related Information

Safety and Performance Information

Power outages and other devices can affect your Cisco Unified IP Phone.

Power Outage

Your accessibility to emergency service through the phone is dependent on the phone being powered. If there is an interruption in the power supply, Service and Emergency Calling Service dialing will not function until power is restored. In the case of a power failure or disruption, you may need to reset or reconfigure equipment before using the Service or Emergency Calling Service dialing.

External Devices

Cisco recommends using good quality external devices (such as headsets) that are shielded against unwanted radio frequency (RF) and audio frequency (AF) signals.

Depending on the quality of these devices and their proximity to other devices such as mobile phones or two-way radios, some audio noise may still occur. In these cases, Cisco recommends that you take one or more of the following actions:

- Move the external device away from the source of the RF or AF signals.
- Route the external device cables away from the source of the RF or AF signals.
- Use shielded cables for the external device, or use cables with a better shield and connector.
- Shorten the length of the external device cable.
- Apply ferrites or other such devices on the cables for the external device.

Cisco cannot guarantee the performance of the system because Cisco has no control over the quality of external devices, cables, and connectors. The system will perform adequately when suitable devices are attached using good quality cables and connectors.



Caution

In European Union countries, use only external speakers, microphones, and headsets that are fully compliant with the EMC Directive [89/336/EC].

Cisco Product Security

This product contains cryptographic features and is subject to United States and local country laws governing import, export, transfer and use. Delivery of Cisco cryptographic products does not imply third-party authority to import, export, distribute or use encryption. Importers, exporters, distributors and users are responsible for compliance with U.S. and local country laws. By using this product you agree to comply with applicable laws and regulations. If you are unable to comply with U.S. and local laws, return this product immediately.

Further information regarding U.S. export regulations may be found at:

http://www.access.gpo.gov/bis/ear/ear_data.html.

Accessibility Features

The Cisco Unified IP Phones 6921, 6941, and 6961 provide accessibility features for the blind, and the visually, hearing, and mobility impaired.

Hearing Impaired Accessibility Features

Accessibility features for the hearing impaired are supported on the Cisco Unified IP Phones 6921, 6941, and 6961.

Although the illustration shows the Cisco Unified IP Phone 6941, the accessibility features described in this section also apply to the Cisco Unified IP Phones 6921 and 6961.



Accessibility Feature	Description	Set Up Requirement
1. Visual Message Waiting Indicator (Handset)	Viewable from 360 degrees, this visual indicator also provides an audible message waiting indicator. Users change the voice message light on their handset and the audible voice message indicator on their phone by logging in to their User Options web pages and accessing the message indicator settings. Users change the setting to on or off.	Standard on all phones; users and system administrators can make changes.
2. Visual Notification of Phone State	<p>For visual notification of the phone state:</p> <ul style="list-style-type: none"> • Toggle the Mute and Speakerphone buttons on and off to indicate the state of the phone. • Use the Mute button to toggle the microphone on or off. When the microphone is muted, the button is lit. • Use the Speakerphone button to toggle the speakerphone on or off. When the speakerphone is on, the button is lit. 	Standard on all phones; no set up is required.
3. Inline Amplifier Support (Handset)	<p>Cisco Unified IP Phone handsets support third-party inline amplifiers, which users attach to the handset and cord and sit between the handset and the IP phone. Cisco Unified IP Phones support the following third-party inline amplifiers:</p> <ul style="list-style-type: none"> • Clarity HA-40 Inline Amplifier for Corded Phone. • Plantronics EHA40 Inline Amplifier. 	Standard on all phones; no set up is required.
4. Adjustable Volume	<p>Users can adjust the volume by:</p> <ul style="list-style-type: none"> • Selecting the Applications > Preferences menu on their phone. • Adjusting the volume level for the phone ringer: while the handset is in the cradle, and the headset and speakerphone buttons are off, press the Volume button to increase the volume. 	Standard on all phones; users and system administrators can make changes.

Accessibility Feature	Description	Set Up Requirement
5. Hearing Aid Compatible (HAC) Handset	Cisco Unified IP Phone handsets support the following accessibility features: <ul style="list-style-type: none"> • Hearing-aid compatible. • Magnetic coupling of the hearing aid. • Federal Communications Commission (FCC) loudness requirements for the Americans with Disabilities Act (ADA). • Section 508 loudness requirements, which are achieved by using industry-standard inline handset amplifiers. 	Standard on all phones; no set up is required.
6. Acoustic Coupled TTY and TDD Support (Handset)	Cisco Unified IP Phones support the following TTY and TDD features: <ul style="list-style-type: none"> • Acoustic or direct connect TTYs from industry-leading manufacturers. • Real-time text transmission over phone lines. • Hearing and voice carry over phones (HCO/VCO). • VoIP network operating at G.711. 	Standard on all Cisco Unified IP Phones. For information about setting up TTY, see your system administrator.
Third-Party Accessibility Applications for the Hearing Impaired	Cisco Unified IP Phones provide an interface for third-party accessibility applications from companies such as NexTalk that support the following features: <ul style="list-style-type: none"> • Paging. • Visual notification. • Ability to provide single number services to support Video Relay, Text Relay, TTY Traffic or voice services. Information about NexTalk is available at: http://www.nextalk.com/products/overview	For more information about third-party applications, see your system administrator.

Vision Impaired and Blind Accessibility Features

Accessibility features for the vision impaired and blind are supported on the Cisco Unified IP Phones 6921, 6941, and 6961.

Although the illustration shows the Cisco Unified IP Phone 6941, the accessibility features described in this section also apply to the Cisco Unified IP Phones 6921 and 6961.



Accessibility Feature	Description	Set Up Requirements
1. High-Contrast Visual and Audible Alert of Incoming Call	Cisco Unified IP Phones provide an audible alert, and the handset provides a visual alert when the phone receives an incoming call. The handset light strip flashes during incoming calls and stays lit when a voice-mail message is received.	Standard on all phones; set up is required.
2. Back-Lit LCD Screen and Programmable Contrast	Users with low vision can adjust the contrast.	Standard on all phones; no set up is required.
3. Line and Feature Buttons	Users can use the line buttons to initiate, answer, or switch to a call on a particular line. Features, such as speed dial, Line Status, Privacy, DND, and Service URLs, can be assigned to feature buttons.	Set up is required. Your system administrator sets up programmable feature buttons to your phone.
4. Large Buttons to Access Applications, Voice Messages, Contacts, Hold, Transfer, and Conference	Large buttons provide to easy access to phone applications, voice messages, corporate and personal directories, and calling features.	Standard on all phones; no set up is required.
5. Audible Notification of Phone State	For audible notification of the phone state, users can: <ul style="list-style-type: none"> • Toggle the Mute and Speakerphone buttons on and off to indicate the state of the phone. • Use the Mute button to toggle the microphone on or off. When the microphone is muted, the button is lit. • Use the Speakerphone button to toggle the speakerphone on or off. When the speakerphone is on, the button is lit. 	Standard on all phones; no set up is required.
6. Standard 12-Key Layout	Cisco Unified IP Phone keypads provide standard 12-key layout, which enables users to use existing or familiar key positions (including a nib on Key 5).	Standard on all phones; no set up is required.

Accessibility Feature	Description	Set Up Requirements
Third-Party Accessibility Applications for the Vision Impaired	<p>Cisco Unified IP Phones 6921, 6941, and 6961 provide an interface for third-party accessibility applications such as Tenacity accessaphone and the IPblue Virtual Telephone/Global Office (VTGO) 508-compliant.</p> <ul style="list-style-type: none"> • VTGO 508-Compliant softphone is a standalone software endpoint that integrates speech application programming interface (SAPI) and which provides audible notification (text-to-speech) of the core functions and features of the Cisco Unified IP Phones. VTGO is also compatible with assistive technology. Information is available at the following URL: http://www.ipblue.com/ • Tenacity accessaphone (AAP) is an assistive technology to the Cisco Unified IP Phones. Through the telephony application programming interface (TAPI) and the computer technology integration (CTI) plug-in, AAP enhances the ability to monitor and control the functions of the Cisco endpoint. Core enhancements are full access through the keyboard and text-to-speech, AAP provides audible notification of the incoming caller ID, full access of call history information, status of the phone and more. Information about Tenacity is available at the following URL: http://www.tenacitycorp.com/products.as 	For more information about third-party application, see your system administrator.
Adjustable Footstand	Users can easily manipulate an adjustable footstand from flat to 60 degrees to provide optimum phone display viewing and comfortable access to all buttons and keys.	Standard on all phones; no set up is required.

Mobility Impaired Accessibility Features

Accessibility features for the mobility impaired are supported on the Cisco Unified IP Phones 6921, 6941, and 6961.

Although the illustration shows the Cisco Unified IP Phone 6941, the accessibility features described in this section also apply to the Cisco Unified IP Phones 6921 and 6961.



192301

Accessibility Feature	Description	Set Up Requirements
1. Well-Spaced, Illuminated Buttons Enable Easy Operation	Depending on set up, programmable feature buttons allow users to access: <ul style="list-style-type: none"> • Phone lines and intercom lines (line buttons) • Speed-dial numbers (speed-dial buttons, including the speed-dial Line Status feature) • Web-based services (for example, a Personal Address Book) • Phone features (for example, Privacy) Buttons illuminate to indicate status: <ul style="list-style-type: none"> • Green, steady—Active call or two-way intercom call • Green, flashing—Held call • Amber, steady—Privacy in use, one-way intercom call, Do Not Disturb (DND) active, or signed in to Hunt Group • Amber, flashing—Incoming call or reverting call • Red, steady—Remote line in use (shared line or Line Status) 	Standard on all phones; no set up is required.
2. Large Buttons to Access Applications, Voice Messages, Contacts, Hold, Transfer, and Conference	Large buttons provide to easy access to phone applications, voice messages, corporate and personal directories, and calling features.	Standard on all phones; no set up is required.
3. Built-In Speakerphone	Users can toggle the speakerphone button on and off to indicate the state of the phone. When the speakerphone is on, the button is lit.	Standard on all phones; no set up is required.
4. Tactile Discernible Buttons and Functions (including a nib on Key 5)	Cisco Unified IP Phone keypads provide the tactile discernible locator, which enables users to use existing or familiar key positions that can be easily located from the “bump” on the Key 5. Users do not have to learn new key positions.	Standard on all phones; no set up is required.

Accessibility Feature	Description	Set Up Requirements
Dedicated Headset Jack that Enables Auto-Answer Function	Users can use a dedicated headset jack that enables auto-answer feature support on either the speakerphone or headset. Incoming calls are then automatically connected after a ring or two.	Standard on all phones; set up is required.
Adjustable Footstand	Users can easily manipulate an adjustable footstand from flat to 60 degrees to provide optimum phone display viewing and comfortable access to all buttons and keys.	Standard on all phones; no set up is required.

Additional Information

Access the most current Cisco Unified IP Phone documentation using these URLs:

- Cisco website:
<http://www.cisco.com/>
- International Cisco websites:
http://www.cisco.com/public/countries_languages.shtml
- Quick start guides for the Cisco Unified IP Phones:
http://www.cisco.com/en/US/products/ps10326/products_user_guide_list.html
- Licensing Information:
http://www.cisco.com/en/US/products/ps10326/products_licensing_information_listing.html

Warranty

Cisco One-Year Limited Hardware Warranty Terms

There are special terms applicable to your hardware warranty and various services that you can use during the warranty period.

Your formal Warranty Statement, including the warranties and license agreements applicable to Cisco software, is available on Cisco.com at the following URL:

http://www.cisco.com/en/US/docs/general/warranty/English/1Y1DEN__.html

Index

A

AAP. *See* accessibility features

access

plugins [76](#)

services [33](#)

access list, create [76](#)

accessibility features

hearing impaired [81](#)

mobility impaired [87](#)

vision impaired and blind [85](#)

add

PAB entry [72](#)

personal directory contact [37](#)

phone services to button [70](#)

remote destination for Mobile Connect [75](#)

administrator settings [34](#)

alerts

audible

accessibility [84](#)

call waiting [48](#)

DND [51](#)

Hold Reversion [53](#)

MCID [56](#)

silent [56](#)

visual

accessibility [83, 86](#)

call waiting [48](#)

DND [51](#)

Hold Reversion [53](#)

line state [4](#)

MCID [56](#)

answer

Auto Answer with headset [43](#)

Auto Answer with speakerphone [43](#)

with Group Pickup and Group Pickup
number [47](#)

with Group Pickup and phone number [48](#)

with Other Pickup [48](#)

with Pickup [47](#)

Applications

Administrator Settings [34](#)

button

Cisco Unified IP Phone 6921 [5](#)

Cisco Unified IP Phone 6941 [14](#)

Cisco Unified IP Phone 6961 [24](#)

Call History [29](#)

Phone Information [33](#)

Preferences [32](#)

Services [33](#)

assign

fast-dial button [73](#)

fast-dial code [74](#)

fast-dial code in Personal Directory [39](#)

fast-dial code to PAB entry [73](#)

PAB to feature a button [72](#)

Assisted Directed Call Park [46](#)
audible alert. *See* alerts, audible
audible message indicator. *See* message
indicators

Auto Answer
description [43](#)
with headset [43](#)
with speakerphone [43](#)

B

BLF. *See* Line Status
blind accessibility features. *See* accessibility
features, vision impaired

browser password, change [70](#)

Busy Lamp Features. *See* Line Status

buttons

Cisco Unified IP Phone 6921 [3](#)

Applications [5](#)

Conference [4](#)

Contacts [5](#)

Headset [4](#)

Hold [4](#)

line [4](#)

Messages [5](#)

Mute [4](#)

Navigation bar [4](#)

softkeys [3](#)

Speakerphone [4](#)

Transfer [4](#)

Volume [5](#)

Cisco Unified IP Phone 6941 [12](#)

Applications [14](#)

Conference [13](#)

Contacts [14](#)

Headset [14](#)

Hold [13](#)

Messages [14](#)

Mute [14](#)

Navigation bar [14](#)

programmable feature [13](#)

Select [14](#)

softkeys [13](#)

Speakerphone [14](#)

Transfer [13](#)

Volume [14](#)

Cisco Unified IP Phone 6961 [22](#)

Applications [24](#)

Conference [23](#)

Contacts [24](#)

Headset [23](#)

Hold [23](#)

Messages [24](#)

Mute [24](#)

Navigation bar [23](#)

programmable feature [23](#)

Select [23](#)

softkeys [22](#)

Speakerphone [23](#)

Transfer [23](#)

Volume [24](#)

feature table [42](#)

C

Call Back

description [43](#)

- set up notification [44](#)
- Call Forward All
 - conditional [44](#)
 - description [44](#)
 - set up
 - on all lines [66](#)
 - on primary line [45](#)
 - unconditional [44](#)
- Call History [29](#)
 - clear [31](#)
 - delete call record [31](#)
 - dial from [30](#)
 - edit number [31](#)
 - filter [30](#)
 - view [30](#)
- call log. *See* call record
- Call Park
 - description [45](#)
 - Directed Call Park
 - assisted [46](#)
 - manual [46](#)
 - Line Status indicator [55](#)
 - Park [46](#)
 - reversion [46](#)
- Call Pickup
 - description [47](#)
 - Group Pickup number [47](#)
 - Group Pickup phone number [48](#)
 - Other Pickup [48](#)
 - Pickup [47](#)
- call record
 - delete [31](#)
 - view details [30](#)
- Call Waiting
 - description [48](#)
 - respond to notification [48](#)
- calling features
 - Auto Answer [43](#)
 - Call Back [43](#)
 - Call Forward All [44](#)
 - Call Park [45](#)
 - Call Pickup [47](#)
 - Call Waiting [48](#)
 - Codes [49](#)
 - Conference [49](#)
 - Divert [51](#)
 - DND [51](#)
 - EM [52](#)
 - Fast Dial [52](#)
 - Hold [53](#)
 - Hold Reversion [53](#)
 - Hunt Group [54](#)
 - Intercom [54](#)
 - Line Status [55](#)
 - MCID [56](#)
 - Meet Me [56](#)
 - Mobile Connect [57](#)
 - Mute [58](#)
 - On-hook Dialing [58](#)
 - Privacy [58](#)
 - QRT [59](#)
 - Redial [59](#)
 - Shared Lines [60](#)
 - Speed Dial [60](#)
 - Transfer [61](#)
 - Web Dialer [62](#)

- caution, external devices **80**
- change
 - browser password **70**
 - contrast **32**
 - language
 - phone display **71**
 - user options web pages **71**
 - locale
 - phone display **71**
 - user options web pages **71**
 - phone line label **67**
 - phone service name **70**
 - phone services **69**
 - ringtones **32**
- check voice messages **40**
- Cisco Mobile Connect. *See* Mobile Connect
- Cisco Unified CM User Options. *See* user options
- Cisco Unified IP Phone 6921
 - buttons and hardware **3**
 - connections **1**
 - footstand **5**
 - handset rest **9**
 - screen
 - description **5**
 - location **3**
- Cisco Unified IP Phone 6941
 - buttons and hardware **12**
 - connections **10**
 - footstand **15**
 - handset rest **19**
 - screen
 - description **15**
 - location **13**
- Cisco Unified IP Phone 6961
 - buttons and hardware **22**
 - connections **20**
 - footstand **24**
 - handset rest **28**
 - screen
 - description **24**
 - location **22**
- clear call history **31**
- Client Matter Codes. *See* CMC
- CMC
 - description **49**
 - using **49**
- conference
 - add a party **50**
 - button
 - Cisco Unified IP Phone 6921 **4**
 - Cisco Unified IP Phone 6941 **13**
 - Cisco Unified IP Phone 6961 **23**
 - combine calls across lines **50**
 - description **49**
 - end **50**
 - Meet Me **56**
 - remove participants **50**
 - swap between calls **50**
 - view participants **50**
- confirmation. *See* alerts
- connecting calls. *See* Transfer
- connections
 - Cisco Unified IP Phone 6921 **1**
 - Cisco Unified IP Phone 6941 **10**
 - Cisco Unified IP Phone 6961 **20**
- connectors. *See* connections

- contacts **35**
 - button
 - Cisco Unified IP Phone 6921 **5**
 - Cisco Unified IP Phone 6941 **14**
 - Cisco Unified IP Phone 6961 **24**
 - corporate directory **35**
 - dial a contact **35**
 - dial a contact while on a call **36**
 - search for a contact **35**
 - search for a contact while on a call **36**
 - personal directory **36**
 - add a contact **37**
 - delete a contact **38**
 - dial a contact **38**
 - edit a contact **38**
 - fast-dial codes **39**
 - search for a contact **37**
 - sign in and out **37**
- contrast **32**
- corporate directory **35**
 - dial **35**
 - dial a contact while on a call **36**
 - search for a contact **35**
 - search for a contact while on a call **36**
- create
 - access list for Mobile Connect **76**
 - conference call **50**
 - phone line label **67**
- CTI. *See* accessibility features
- customize voicemail **40**

D

- delete
 - call history record **31**
 - fast-dial code from personal directory **39**
 - PAB entry **72**
 - personal directory contact **38**
- device settings. *See* user options
- dial
 - corporate directory contact **35**
 - fast-dial code from personal directory **39**
 - from call history **30**
 - on-hook **58**
 - personal directory contact **38**
- Direct Transfer **61**
- Directed Call Park
 - assisted **46**
 - description **45**
 - manual **46**
- directory **35**
 - corporate **35**
 - dial a contact **35**
 - dial a contact while on a call **36**
 - search for a contact **35**
 - search for a contact while on a call **36**
 - with Web Dialer **62**
 - personal **36**
 - add a contact **37**
 - delete a contact **38**
 - dial a contact **38**
 - edit a contact **38**
 - fast-dial codes **39**
 - search for a contact **37**
 - sign in and out **37**

user options [71](#)

Divert

description [51](#)

redirect a call [51](#)

DND

customize [65](#)

description [51](#)

turn on and off [51](#)

Do Not Disturb. *See* DND

documentation, related [90](#)

E

edit

call history number [31](#)

fast dials [74](#)

PAB entry [72](#)

personal directory contact [38](#)

EM

description [52](#)

enable [52](#)

enable

EM [52](#)

Privacy [59](#)

end

conference [50](#)

phone services [69](#)

Extension Mobility. *See* EM

external devices

caution [80](#)

information [80](#)

F

FAC

description [49](#)

using [49](#)

FAQs [77](#)

fast dials [73](#)

assign a code [74](#)

assign a code to PAB entry [73](#)

assign to a feature button [73](#)

description [52](#)

edit [74](#)

place a call

with a fast-dial button [52](#)

search [74](#)

fast-dial codes

assign to Personal Directory [39](#)

delete from personal directory [39](#)

fast-dials

place a call with a fast-dial code [39](#)

feature buttons and softkeys table [42](#)

features. *See* calling features

filter call history [30](#)

flashing. *See* alerts, visual

footstand

Cisco Unified IP Phone 6921 [5](#)

Cisco Unified IP Phone 6941 [15](#)

Cisco Unified IP Phone 6961 [24](#)

Forced Authorization Codes. *See* FAC

forward. *See* Call Forward All

frequently asked questions. *See* FAQs

G

Group Pickup

- answer [47](#)
- answer with number [48](#)
- description [47](#)

H

HAC. *See* accessibility features

handset

- Cisco Unified IP Phone 6921
 - light strip [3](#)
 - location [5](#)
 - rest [9](#)

- Cisco Unified IP Phone 6941
 - light strip [13](#)
 - location [14](#)
 - rest [19](#)

- Cisco Unified IP Phone 6961
 - light strip [22](#)
 - location [24](#)
 - rest [28](#)

hardware

- Cisco Unified IP Phone 6921 [3](#)
- Cisco Unified IP Phone 6941 [12](#)
- Cisco Unified IP Phone 6961 [22](#)
- warranty [91](#)

header. *See* screen

Headset

- Auto Answer [43](#)
- button
 - Cisco Unified IP Phone 6921 [4](#)
 - Cisco Unified IP Phone 6941 [14](#)

- Cisco Unified IP Phone 6961 [23](#)
- hearing impaired accessibility features [81](#)

Hold

- button
 - Cisco Unified IP Phone 6921 [4](#)
 - Cisco Unified IP Phone 6941 [13](#)
 - Cisco Unified IP Phone 6961 [23](#)
- description [53](#)
- on shared lines [53](#)
- swap between calls [53](#)
- with a new call [53](#)

Hold Reversion

- description [53](#)
- notification [53](#)
- responding to notification [54](#)

Hunt Group

- description [54](#)
- sign in and out [54](#)

I

icons, Line Status [55](#)

iDivert. *See* Divert

Intercom

- description [54](#)
- place a call [54](#)
- receive a call [55](#)
- whisper [54](#)

K

keypad

- accessibility

- mobility impaired [89](#)
- visually impaired and blind [86](#)
- Cisco Unified IP Phone 6921 [4](#)
- Cisco Unified IP Phone 6941 [14](#)
- Cisco Unified IP Phone 6961 [23](#)

L

- language
 - change for user options web pages [71](#)
 - change phone display [71](#)
 - Web Dialer settings [63](#)
- LED. *See* lights
- licensing information [90](#)
- lights
 - amber, flashing [4](#)
 - green
 - flashing [4](#)
 - steady [4](#)
 - handset [3](#)
 - red
 - flashing [4](#)
 - steady [4](#)
- line
 - buttons, Cisco Unified IP Phone 6921 [4](#)
 - settings [66](#)
 - Call Forward [66](#)
 - DND [65](#)
 - ring [67](#)
 - voice message indicator [66](#), [67](#)
 - text label
 - change [67](#)
 - create [67](#)

- Line Status
 - description [55](#)
 - icons [55](#)
 - indicators [55](#)
- listen to voice messages [41](#)

- locale
 - change for user options web pages [71](#)
 - change phone display [71](#)
- log in and out. *See* sign in and out
- logs. *See* Call History

M

- MAC address
 - phone information [33](#)
 - Web Dialer [63](#)
- Malicious Caller ID. *See* MCID
- Manual Directed Call Park [46](#)
- MCID
 - description [56](#)
 - trace a call [56](#)
- Meet Me
 - conference
 - host [56](#)
 - join [56](#)
 - description [56](#)
- menu
 - Applications [14](#)
 - Directories [14](#)
- message indicators [40](#)
 - audible, change [67](#)
 - voice, change [66](#)
- messages

- button
 - Cisco Unified IP Phone 6921 [5](#)
 - Cisco Unified IP Phone 6941 [14](#)
 - Cisco Unified IP Phone 6961 [24](#)
- check for [40](#)
- listen to [41](#)
- personalize voicemail [40](#)
- missed calls [29](#)
- Mobile Connect
 - add remote destination [75](#)
 - create access list [76](#)
 - description [57](#)
 - switch
 - from Desk to Mobile Phone [57](#)
 - from Mobile Phone to Desk [58](#)
 - turn on and off [57](#)
- mobility impaired accessibility features [87](#)
- model information [33](#)
- mute
 - button
 - Cisco Unified IP Phone 6921 [4](#)
 - Cisco Unified IP Phone 6941 [14](#)
 - Cisco Unified IP Phone 6961 [24](#)
 - description [58](#)
 - turn on and off [58](#)

N

- Navigation bar
 - Cisco Unified IP Phone 6921 [4](#)
 - Cisco Unified IP Phone 6941 [14](#)
 - Cisco Unified IP Phone 6961 [23](#)
- notification

- Call Back [44](#)
- Call Waiting [48](#)
- Hold reversion [53](#)
- See also* alerts

O

- On-hook Dialing
 - description [58](#)
 - dial a number [58](#)
- Other Pickup
 - answer [48](#)
 - description [47](#)

P

- PAB
 - add [72](#)
 - assign to a feature button [72](#)
 - delete [72](#)
 - edit [72](#)
 - search [72](#)
- park. *See* Call Park
- password. *See* browser password
- personal address book. *See* PAB
- personal directory [36](#)
 - add a contact [37](#)
 - delete a contact [38](#)
 - dial a contact [38](#)
 - edit a contact [38](#)
 - fast-dial codes [39](#)
 - search for a contact [37](#)
 - sign in and out [37](#)

- personalize voicemail [40](#)
- phone display
 - change language [71](#)
 - change line label [67](#)
 - create line label [67](#)
- phone information, model [33](#)
- phone problem, report with QRT [59](#)
- phone services
 - access [33](#)
 - add to button [70](#)
 - change name [70](#)
 - search for [69](#)
 - subscribe to [69](#)
- pickup. *See* Call Pickup
- placed calls [29](#)
- plugins [76](#)
- power outage [80](#)
- preferences [32](#)
 - contrast [32](#)
 - ringtones [32](#)
 - Web Dialer [63](#)
- Privacy
 - description [58](#)
 - enable on a shared line [59](#)
- problem report with QRT [59](#)
- product security [81](#)
- programmable feature buttons
 - Cisco Unified IP Phone 6941 [13](#)
 - Cisco Unified IP Phone 6961 [23](#)

Q

QRT

- description [59](#)
- report phone problem [59](#)

R

- received calls [29](#)
- Redial
 - a number [59](#)
 - description [59](#)
- redirect a call [51](#)
- related documentation [90](#)
- remote destination. *See* user options
- remove participants from conference [50](#)
- report phone problem [59](#)
- revert, call
 - on hold [53](#)
 - parked [46](#)
- ring setting, change [67](#)
- ringtones [32](#)

S

- safety and performance
 - external devices [80](#)
 - power outage [80](#)
- screen
 - Cisco Unified IP Phone 6921
 - description [5](#)
 - location [3](#)
 - Cisco Unified IP Phone 6941
 - description [15](#)
 - location [13](#)
 - Cisco Unified IP Phone 6961

- description [24](#)
- location [22](#)
- search
 - corporate directory [35](#)
 - fast dials [74](#)
 - PAB [72](#)
 - personal directory [37](#)
 - phone services [69](#)
- security, product [81](#)
- Select button. *See* Navigation bar
- services. *See* phone services
- set
 - contrast [32](#)
 - ringtones [32](#)
- set up
 - speed-dial buttons [68](#)
 - speed-dial codes [68](#)
 - Web Dialer preferences [63](#)
- shared lines
 - description [60](#)
 - enable Privacy [59](#)
 - on hold [53](#)
- sign in and out
 - Hunt Group [54](#)
 - personal directory [37](#)
 - user options [64](#)
 - Web Dialer [62](#), [63](#)
- softkeys
 - Cisco Unified IP Phone 6921 [3](#)
 - Cisco Unified IP Phone 6941 [13](#)
 - Cisco Unified IP Phone 6961 [22](#)
 - feature table [42](#)
- Speakerphone

- Auto Answer with [43](#)
- button
 - Cisco Unified IP Phone 6921 [4](#)
 - Cisco Unified IP Phone 6941 [14](#)
 - Cisco Unified IP Phone 6961 [23](#)
- Speed Dial
 - buttons [68](#)
 - description [60](#)
 - place a call [61](#)
 - set up [68](#)
 - codes
 - description [60](#)
 - place a call [61](#)
 - set up [68](#)
 - Line Status indicator [55](#)
- status
 - buttons [4](#)
- stutter tone [40](#)
- subscribe to phone services [69](#)
- suspicious call, trace [56](#)
- swap
 - conference calls [50](#)
 - held calls [53](#)
 - transfer calls [62](#)

T

- To Voicemail. *See* Divert
- trace a suspicious call [56](#)
- Transfer
 - button
 - Cisco Unified IP Phone 6921 [4](#)
 - Cisco Unified IP Phone 6941 [13](#)

- Cisco Unified IP Phone 6961 [23](#)
- description [61](#)
- Direct Transfer [62](#)
- swap [62](#)
- troubleshooting tips [77](#)
- TTY. *See* accessibility features
- turn on and off
 - DND [51](#)
 - Mobile Connect [57](#)
 - mute [58](#)

U

- user options
 - device
 - line settings [66](#)
 - select [65](#)
 - speed dial [68](#)
 - directory [71](#)
 - fast dials [73](#)
 - assign a code [74](#)
 - assign a code to PAB entry [73](#)
 - assign to a feature button [73](#)
 - edit [74](#)
 - search [74](#)
 - mobility [75](#)
 - add remote destination [75](#)
 - create access list [76](#)
 - PAB [72](#)
 - add entry [72](#)
 - assign to a feature button [72](#)
 - delete entry [72](#)
 - edit entry [72](#)

- search for entry [72](#)
- plugins [76](#)
- sign in and out [64](#)
- user settings
 - change browser password [70](#)
 - change phone display language [71](#)
 - change user options web pages language [71](#)
- user preferences. *See* preferences

V

- view
 - call history [30](#)
 - call record details [30](#)
 - conference participants [50](#)
 - missed calls [29](#)
 - phone information [33](#)
 - placed calls [29](#)
 - received calls [29](#)
 - Web Dialer preferences [63](#)
- viewing angle. *See* footstand
- vision impaired and blind accessibility features [85](#)
- visual alert. *See* alerts, visual
- voice messages. *See* messages
- voicemail. *See* messages
- Volume
 - Cisco Unified IP Phone 6921 [5](#)
 - Cisco Unified IP Phone 6941 [14](#)
 - Cisco Unified IP Phone 6961 [24](#)

W

- warranty [91](#)

Web Dialer

- change preferences [63](#)
 - description [62](#)
 - MAC address [63](#)
 - set up preferences [63](#)
 - sign in [62](#)
 - sign out [63](#)
 - view preferences [63](#)
 - with Cisco Directory [62](#)
 - with corporate directory [62](#)
- whisper [54](#)



Americas Headquarters
Cisco Systems, Inc.
San Jose, CA

Asia Pacific Headquarters
Cisco Systems (USA) Pte. Ltd.
Singapore

Europe Headquarters
Cisco Systems International BV
Amsterdam, The Netherlands

Cisco has more than 200 offices worldwide. Addresses, phone numbers, and fax numbers are listed on the
Cisco Website at www.cisco.com/go/offices.

CCDE, CCENT, CCSI, Cisco Eos, Cisco HealthPresence, Cisco Ironport, the Cisco logo, Cisco Lumin, Cisco Nexus, Cisco Nurse Connect, Cisco Stackpower, Cisco StadiumVision, Cisco TelePresence, Cisco Unified Computing System, Cisco WebEx, DCE, Flip Channels, Flip for Good, Flip Mino, Flip Video, Flip Video (Design), Flipshare (Design), Flip Ultra, and Welcome to the Human Network are trademarks; Changing the Way We Work, Live, Play, and Learn, Cisco Store, and Flip Gift Card are service marks; and Access Registrar, Aironet, AsyncOS, Bringing the Meeting To You, Catalyst, CCDA, CCDP, CCIE, CCIP, CCNA, CCNP, CCSP, CCGVP, Cisco, the Cisco Certified Internetwork Expert logo, Cisco IOS, Cisco Press, Cisco Systems, Cisco Systems Capital, the Cisco Systems logo, Cisco Unity, Collaboration Without Limitation, EtherFast, EtherSwitch, Event Center, Fast Step, Follow Me Browsing, FormShare, GigaDrive, HomeLink, Internet Quotient, IOS, iPhone, iQuick Study, IronPort, the IronPort logo, LightStream, Linksys, MediaTone, MeetingPlace, MeetingPlace Chime Sound, MGX, Networkers, Networking Academy, Network Registrar, PCNow, PIX, PowerPanels, ProConnect, ScriptShare, SenderBase, SMARTnet, Spectrum Expert, StackWise, The Fastest Way to Increase Your Internet Quotient, TransPath, WebEx, and the WebEx logo are registered trademarks of Cisco Systems, Inc. and/or its affiliates in the United States and certain other countries.

All other trademarks mentioned in this document or website are the property of their respective owners. The use of the word partner does not imply a partnership relationship between Cisco and any other company. (0907R)



The Java logo is a trademark or registered trademark of Sun Microsystems, Inc. in the U.S. or other countries.